

FX Inverter/Charger

FX and VFX Mobile Series

Installation Manual



About OutBack Power Technologies

OutBack Power Technologies is a leader in advanced energy conversion technology. OutBack products include true sine wave inverter/chargers, maximum power point tracking charge controllers, and system communication components, as well as circuit breakers, batteries, accessories, and assembled systems.

Applicability

These instructions apply to OutBack inverter/charger models FX2012MT, FX2024M, FX2524MT, FX2532MT, FX2536MT, FX3048MT, VFX2812M, VFX3524M, VFX3232M, VFX3236M, and VFX3648M only.

Contact Information

Address:	Corporate Headquarters 17825 – 59 th Avenue N.E. Suite B Arlington, WA 98223 USA	European Office Hansastraße 8 D-91126 Schwabach, Germany
Telephone:	+1.360.435.6030 +1.360.618.4363 (Technical Support) +1.360.435.6019 (Fax)	+49.9122.79889.0 +49.9122.79889.21 (Fax)
Email:	Support@outbackpower.com	
Website:	http://www.outbackpower.com	

Disclaimer

UNLESS SPECIFICALLY AGREED TO IN WRITING, OUTBACK POWER TECHNOLOGIES:

(a) MAKES NO WARRANTY AS TO THE ACCURACY, SUFFICIENCY OR SUITABILITY OF ANY TECHNICAL OR OTHER INFORMATION PROVIDED IN ITS MANUALS OR OTHER DOCUMENTATION.

(b) ASSUMES NO RESPONSIBILITY OR LIABILITY FOR LOSS OR DAMAGE, WHETHER DIRECT, INDIRECT, CONSEQUENTIAL OR INCIDENTAL, WHICH MIGHT ARISE OUT OF THE USE OF SUCH INFORMATION. THE USE OF ANY SUCH INFORMATION WILL BE ENTIRELY AT THE USER'S RISK.

OutBack Power Technologies cannot be responsible for system failure, damages, or injury resulting from improper installation of their products.

Information included in this manual is subject to change without notice.

Notice of Copyright

FX and VFX Mobile Series Inverter/Charger Installation Manual © 2016 by OutBack Power Technologies. All Rights Reserved.

Trademarks

OutBack Power, the OutBack Power logo, FLEXware, and OPTICS RE are trademarks owned and used by OutBack Power Technologies, Inc. The ALPHA logo and the phrase "member of the Alpha Group" are trademarks owned and used by Alpha Technologies Inc. These trademarks may be registered in the United States and other countries.

Date and Revision

August 2016, Revision A

Part Number

900-0197-01-00 Rev A



Table of Contents

Introduction	5
Audience	5
Symbols Used	5
Welcome to OutBack Power Technologies.....	6
General Safety	6
Models.....	7
Sealed Mobile Models	7
Vented Mobile Models	7
Inverter Model Names.....	7
Components and Accessories	8
Planning	9
Applications	9
Renewable Energy.....	10
Battery Bank.....	10
Generator.....	12
Installation	13
Location and Environmental Requirements.....	13
Tools Required.....	13
Mounting.....	14
Dimensions.....	14
Terminals and Ports.....	15
Wiring	16
Grounding	16
DC Wiring	18
AC Wiring.....	21
AC Sources.....	22
ON and OFF Wiring.....	23
Accessory Wiring.....	23
AUX Wiring	24
Generator Control.....	25
AC Configurations.....	27
Single-Inverter.....	27
Multiple-Inverter AC Installations (Stacking)	28
Stacking Configurations	30
Commissioning	41
Functional Test.....	41
Pre-startup Procedures	41
Startup	41
Powering Down.....	43
Adding New Devices.....	43
Operation	43
Definitions.....	43
Index	45

List of Tables

Table 1	Components and Accessories	8
Table 2	Battery Bank Elements	11
Table 3	Ground Conductor Size and Torque Requirements.....	16
Table 4	DC Conductor Size and Torque Requirements	18
Table 5	Stacking Modes for Mobile FX Inverters.....	29
Table 6	Terms and Definitions.....	43

List of Figures

Figure 1	FX Mobile Series Inverter/Charger with Turbo Fan	6
Figure 2	Components.....	8
Figure 3	Applications (Example)	9
Figure 4	Dimensions	14
Figure 5	Terminals, Ports, and Features	15
Figure 6	DC Ground Lug.....	17
Figure 7	Chassis Ground	17
Figure 8	Required Order of Battery Cable Hardware	19
Figure 9	Battery Terminal Covers	19
Figure 10	DC Cover Attachment	20
Figure 11	Turbo Fan Wiring	20
Figure 12	AC Terminals	21
Figure 13	AC Sources	22
Figure 14	AC Sources and Transfer Relay	22
Figure 15	ON/OFF Jumper and Connections	23
Figure 16	Accessory Connections	23
Figure 17	AUX Connections for Vent Fan (Example)	24
Figure 18	Two-Wire Generator Start (Example).....	25
Figure 19	Three-Wire Generator Start (Example)	26
Figure 20	Single-Inverter Wiring.....	27
Figure 21	OutBack HUB10.3, MATE2 , and MATE3.....	28
Figure 22	Example of Classic Series Stacking Arrangement	30
Figure 23	Classic Series Wiring	31
Figure 24	Example of OutBack Series Stacking Arrangement	32
Figure 25	OutBack Series Wiring (Two Inverters).....	33
Figure 26	Example of Parallel Stacking Arrangement (Three Inverters)	34
Figure 27	Parallel Wiring (Four Inverters)	35
Figure 28	Example of Series/Parallel Stacking Arrangement (Four Inverters)	36
Figure 29	Series/Parallel Wiring (Four Inverters)	37
Figure 30	Example of Three-Phase Stacking Arrangement (Three Inverters)	38
Figure 31	Three-Phase Wiring (Three Inverters)	39
Figure 32	AC Terminals	42







Introduction

Audience

This book provides instructions for the physical installation and wiring of this product. These instructions are for use by qualified personnel who meet all local and governmental code requirements for licensing and training for the installation of electrical power systems with AC and DC voltage up to 600 volts. This product is only serviceable by qualified personnel.

Symbols Used

	<p>WARNING: Hazard to Human Life</p> <p>This type of notation indicates that the hazard could be harmful to human life.</p>
	<p>CAUTION: Hazard to Equipment</p> <p>This type of notation indicates that the hazard may cause damage to the equipment.</p>
	<p>IMPORTANT:</p> <p>This type of notation indicates that the information provided is important to the installation, operation and/or maintenance of the equipment. Failure to follow the recommendations in such a notation could result in voiding the equipment warranty.</p>
	<p>NOTE:</p> <p>This type of notation indicates that the information provided is important to understanding the operation and limits of the equipment. Failure to follow the recommendations in such a notation could result in improper or failed operation.</p>



MORE INFORMATION

When this symbol appears next to text, it means that more information is available in other manuals relating to the subject. The most common reference is to the *FX and VFX Mobile Series Inverter/Charger Operator's Manual*. Another common reference is the system display manual.

Introduction

Welcome to OutBack Power Technologies



Thank you for purchasing the OutBack FX Mobile Series Inverter/Charger. This product offers a complete power conversion system between batteries, shore power, and generator.

- 12-, 24-, 32-, 36-, and 48-volt models
- Output power from 2.0 kVA to 3.6 kVA
- Designed to be integrated as part of a full system using FLEXware™ components
- Battery (DC)-to-AC inverting with single-phase 120 Vac output at 60 Hz
- Shore power (AC)-to-battery (DC) charging (FX systems are battery-based)
- Rapid transfer between shore power (AC source) and inverter output with minimal delay time
- Uses the MATE™, MATE2™ or MATE3™ System Display and Controller or the AXS Port™ SunSpec Modbus Interface (all sold separately) for user interface
- Supports the OPTICS RE™ online tool¹ for a cloud-based remote monitoring and control application
 - ~ Requires the MATE3 or the AXS Port
 - ~ Visit www.outbackpower.com to download
- Uses the HUB4™ or HUB10.3™ Communications Manager (sold separately) for stacking
 - ~ Stackable in series (OutBack or Classic), parallel, series/parallel, and three-phase configurations
- Automatic neutral-to-ground bond switching
- Listed to ANSI/UL 458 (5th Edition) and CSA 22.2 by ETL



Figure 1 FX Mobile Series Inverter/Charger with Turbo Fan

General Safety

	WARNING: Limitations on Use This equipment is NOT intended for use with life support equipment or other medical equipment or devices.
	WARNING: Reduced Protection If this product is used in a manner not specified by FX product literature, the product's internal safety protection may be impaired.
	CAUTION: Equipment Damage Only use components or accessories recommended or sold by OutBack Power Technologies or its authorized agents.

¹Outback Power Technologies Intuitive Control System for Renewable Energy

Models

Sealed Mobile Models

Sealed inverter models are designed for dusty and humid environments and can survive casual exposure to the elements. However, enclosed protection is still recommended. These inverters are internally ventilated and do not use outside air for cooling. To compensate, most sealed models are also equipped with the OutBack Turbo Fan assembly which uses external air to remove heat from the chassis.

- FX2012MT (2.0 kVA output, 12 Vdc)
- FX2024M (2.0 kVA output, 24 Vdc)
- FX2524MT (2.5 kVA output, 24 Vdc)
- FX2532MT (2.5 kVA output, 32 Vdc)
- FX2536MT (2.5 kVA output, 36 Vdc)
- FX3048MT (3.0 kVA output, 48 Vdc)

Vented Mobile Models

Vented inverter models are intended for indoor or protected installation only. On average, the wattage of vented models is rated higher than sealed models. This is due to the greater cooling capabilities of the vented models.

- VFX2812M (2.8 kVA output, 12 Vdc)
- VFX3524M (3.5 kVA output, 24 Vdc)
- VFX3232M (3.2 kVA output, 32 Vdc)
- VFX3236M (3.6 kVA output, 36 Vdc)
- VFX3648M (3.6 kVA output, 48 Vdc)

Inverter Model Names

FX mobile model numbers use the following naming conventions.

- The model number includes “FX” as the inverter series.
- Vented models are preceded with “V”, as in “VFX3648M”.
- The first two digits show the power of that model. For example, “FX2012MT” is 2000 watts.
- The second pair of digits shows the inverter’s nominal DC voltage. For example, “FXR2524MT” is 24 volts.
- Models equipped with a Turbo Fan end with the letter “T”. This designation indicates a sealed model. Vented FX inverter models are not equipped with Turbo Fans. (Model FX2024M is a sealed model without a Turbo Fan.)
- Mobile models (all models featured in this manual) use the letter “M” as either the last or second to last character (as in “FX2012MT” or “VFX2012M”). These models are meant to be installed in a vehicle and should not be installed anywhere else. Similarly, a non-mobile inverter should not normally be installed in a vehicle. For this reason this manual refers to “M” series inverters as “mobile”.² The instructions assume they are installed accordingly.



IMPORTANT:

Installing an inverter in the wrong application invalidates its listing, may violate installation codes, and may void the inverter’s warranty.

² Other inverters, if they are referenced, are referred to as “permanently installed.”

Components and Accessories

Table 1 Components and Accessories

Components to be Installed	Accessories Included
Battery Terminal Cover, red	FX Mobile Series Installation Manual (this book)
Battery Terminal Cover, black	FX Mobile Series Operator's Manual
AC Plate	"WARNING ELECTRICAL SHOCK" sticker
DC Cover (DCC) or Turbo Fan	Silicone Grease Packet
Remote Temperature Sensor (RTS)	

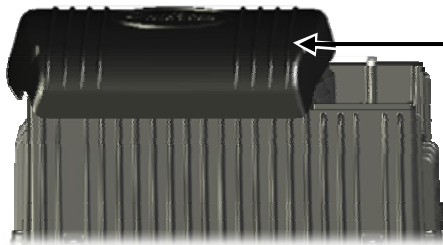

DCC (DC Cover)

This covers the DC terminal area on vented inverters. The DCC provides space to mount other components such as a DC current shunt.



AC Plate

This plate is used for installations which do not utilize OutBack's optional FLEXware conduit boxes. The knockouts are used to install strain relief for flexible cable.

NOTE: This plate is not to be connected to conduit.

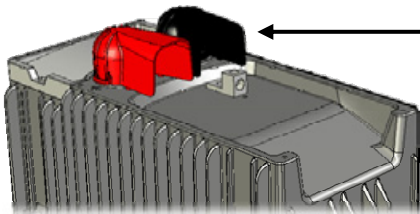

Battery Terminal Cover

These protect the terminals from accidental contact. They are made of stiff plastic with a snap-on design.

Always keep covers installed during operation.

Turbo Fan Cover

Included in place of the DCC on sealed inverters. Convectively cools chassis with the external OutBack Turbo Fan to allow maximum power.

NOTE: Do not install the Turbo Fan on a vented inverter.

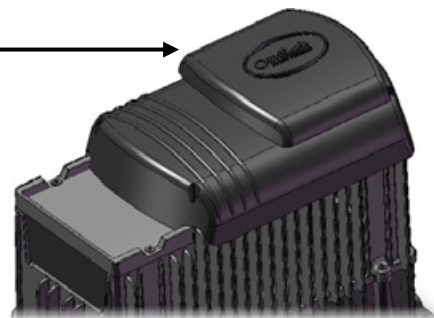

NOTE: The DC Cover or Turbo Fan does not replace the battery terminal covers. These covers must be installed in addition to the DCC or fan.

Figure 2 Components



Planning

Applications

OutBack inverter/chargers are designed to use a battery bank to store energy. In shore-based mobile and marine connections, the shore power is used as the primary source. When the shore power is removed, the inverter takes over to run the loads from the batteries. The settings can be changed to accommodate many applications. Changes are made with the system display. 

Mobile FX inverter/chargers work together with power from the utility grid (shore power), generator, vehicle alternator, and/or renewable energy sources such as photovoltaic (PV) modules. When not using the batteries, the inverter can charge it from an AC source. The alternator, PV harvest, or other DC sources can also be used to recharge the batteries.

The FX inverter has one set of terminals for a single AC source. However, it can use two AC sources when an external transfer switch is installed. The inverter can be independently programmed for each source. It is common to use shore power and an AC generator. Other combinations of AC sources are possible.

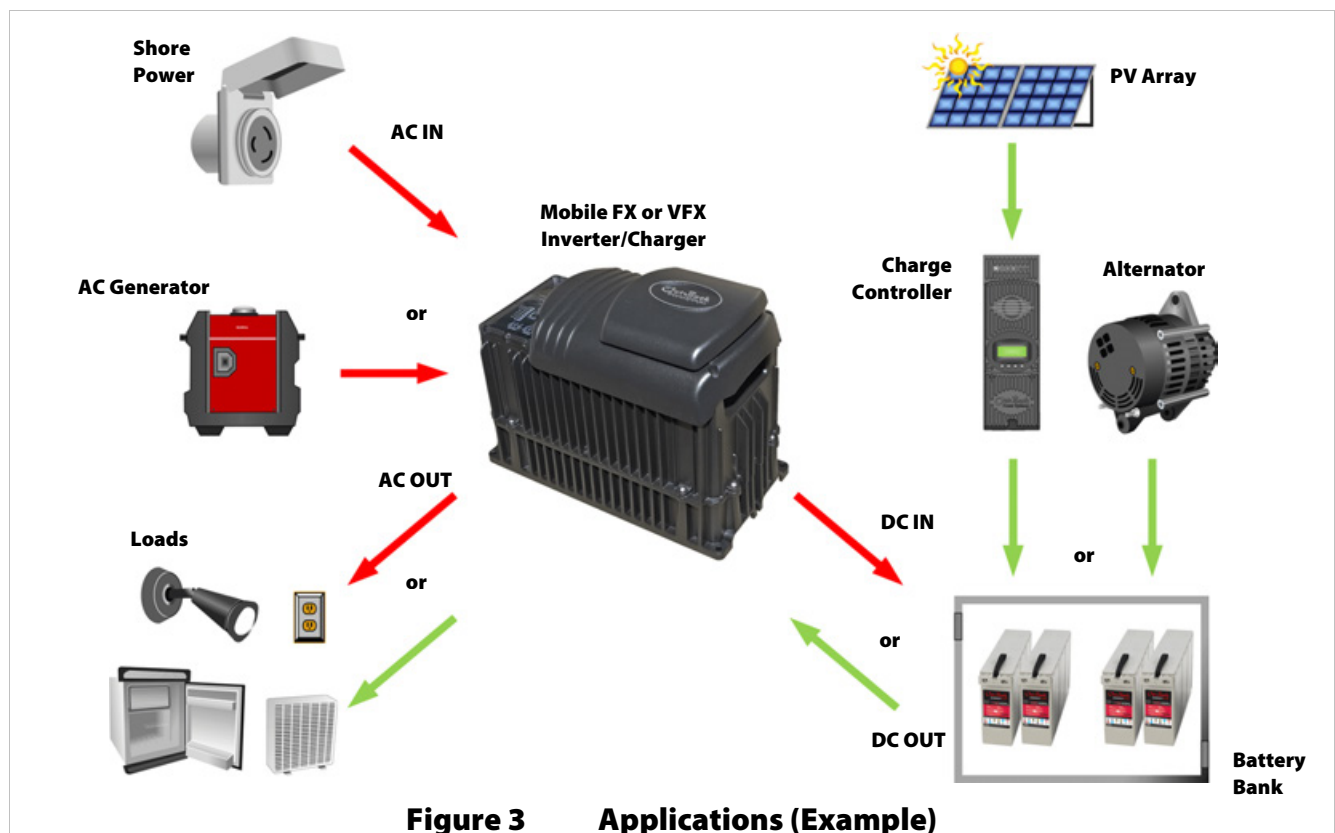

Programming

Selection of all inverter programming is performed using a system display such as the MATE, MATE2, or MATE3. The system display can customize a wide range of parameters. 

Renewable Energy



The inverter cannot connect directly to PV, alternators, or other DC sources. The batteries are the inverter's primary source of power. However, if the DC sources are used to charge the batteries, the inverter can use their energy by drawing it from the batteries.

A renewable source is always treated as a battery charger, even if all of its power is used immediately. The renewable source must have a charge controller, or some other regulation method, to prevent overcharging. OutBack Power's FLEXmax family of charge controllers can be used for this purpose, as can other products.

Battery Bank

When planning a battery bank, consider the following:

- **Cables:** Recommendations for battery cable size and length are shown on page 18. The maximum length will determine the placement of the battery bank. Local codes or regulations may apply and will take priority over OutBack recommendations.
- **Battery Type:** The FX inverter/charger uses a three-stage charge cycle.
 - ~ The cycle was designed for lead-chemistry batteries intended for deep discharge. These include batteries for RV, marine, golf-cart, and forklift applications. They also include gel-cell batteries and absorbed glass-mat (AGM) batteries. OutBack Power recommends the use of batteries designed specifically for renewable energy applications. Automotive batteries are strongly discouraged and will have a short life if used in inverter applications.
 - ~ Lithium-based batteries and other advanced battery technologies may require special considerations. Please contact OutBack Technical Support at **+1.360.618.4363** before implanting advanced technologies.
- **Nominal Voltage:** These inverters are designed to work with specific battery bank voltages, which are different depending on inverter model. Before constructing a battery bank, check the inverter model and confirm nominal battery voltage.
- **Charger Settings and Maintenance:** A vented battery enclosure may be required by electric code and is usually recommended for safety reasons. It may be necessary to use a fan to ventilate the battery enclosure. Batteries must be regularly maintained according to the instructions of the battery manufacturer.

	IMPORTANT: Battery charger settings need to be correct for a given battery type. Always follow battery manufacturer recommendations. Making incorrect settings, or leaving them at factory default settings, may cause the batteries to be undercharged or overcharged.
	CAUTION: Hazard to Equipment Batteries can emit vapors which are corrosive over long periods of time. Installing the inverter in the battery compartment may cause corrosion which is not covered by the product warranty. (Sealed batteries may be an exception.)

- **Bank Size:** Battery bank capacity is measured in amp-hours. Determine the required bank specifications as accurately as possible, beginning with the items below. This avoids underperformance or wasted capacity. These ten items are obtainable in different places, summarized in Table 2 on the next page. Some of the information is specific to the site or application. Some can be obtained from the battery manufacturer. Information on OutBack products is available from OutBack Power Technologies or its dealers.
 - A. Size of load:
 - B. Daily hours of use:
 - C. Days of autonomy:

} These are the most basic and essential factors used to determine bank size.

- D. Application: This often helps define or prioritize the previous three items. Off-grid systems often require enough capacity to last for an extended period before recharging. Grid-connected systems frequently need only enough capacity for short-term backup during outages.

- E. Conductor efficiency: Wire size and other factors will waste power due to resistance and voltage drop. Typical acceptable efficiency is 96 to 99%.
- F. Inverter efficiency: FX specifications list “Typical Efficiency” to help estimate operating loss.
- G. System DC voltage: Each inverter model requires a specific DC voltage to operate.
- H. Battery voltage: Most individual battery voltages are less than the system DC voltage. The batteries may need to be placed in series to deliver the correct voltage.
- I. Capacity: Battery capacity, which is measured in amp-hours, is not usually a fixed number. It is specified based on the rate of discharge. For example, the OutBack EnergyCell 200RE is rated at 134.5 Ahr when discharged at the 5-hour rate (to terminal voltage 1.85 Vpc). This is a high rate of discharge that would hypothetically drain the battery in 5 hours. The same battery is rated at 191 Ahr when used at the 100-hour rate. Use the appropriate discharge rate (correlated to the expected loads) to measure the capacity of a battery. Use battery specifications for terminal voltage 1.85 Vpc whenever possible.
NOTE: Capacity ratings are for batteries at 25°C. Capacity is reduced at cooler temperatures.
- J. Maximum depth of discharge (DoD): Most batteries cannot be discharged below a certain level without damage. The bank requires enough total capacity to keep this from happening.

Any losses are essentially amp-hour capacity that the system cannot use. The battery bank size can be increased to account for losses.

Table 2 Battery Bank Elements

Item	Source of information
A. Load Size	Site-specific
B. Daily Hours	Site-specific
C. Days of Autonomy	Site-specific
D. Application	Site-specific
E. Conductor Efficiency	Site-specific
F. Inverter Efficiency	Inverter manufacturer
G. System Vdc	Inverter manufacturer
H. Battery Vdc	Battery manufacturer
I. Capacity	Battery manufacturer
J. Maximum DoD	Battery manufacturer

To Calculate Minimum Battery Bank Size (refer to Table 2 for letter designations):

1. The load size, item A, is measured in watts. Compensate this figure for efficiency loss. Multiply the conductor efficiency by the inverter efficiency (E x F). (These items are represented as percentages, but may be displayed as decimals for calculation.) Divide item A by the result.
2. Convert the compensated load into amperes (Adc). Divide the step 1 result by the system voltage (item G).
3. Determine the daily load consumption in ampere-hours (amp-hours, or Ahr). Multiply the step 2 result by the daily usage hours (item B).
4. Adjust the total for required days of autonomy (the days the system must operate without recharging) and the maximum DoD. Multiply the step 3 result by C and divide by J.
The result is the total amp-hour capacity required for the battery bank.
5. Determine the number of parallel battery strings required. Divide the Ahr figure from step 4 by the individual battery capacity (I). Round the result to the next highest whole number.
6. Determine the total number of batteries required. Divide the system voltage by the battery voltage (G ÷ H). Multiply the result by the step 5 result.
The result is the total required quantity of the chosen battery model.

EXAMPLE #1

- | | |
|---|--|
| A. Loads: 0.5 kW (500 W) | 1) $A \div [E \times F]$ $500 \div (0.98 \times 0.9) = 566.9 \text{ W}$ |
| B. Hours of use: 6 | 2) $1 \div G$ $566.9 \div 12 = 47.2 \text{ Adc}$ |
| C. Days of autonomy: 1 | 3) $2 \times B$ $47.2 \times 6 = 283.4 \text{ Ahr}$ |
| D. Grid-interactive system (FX2012MT inverter) | 4) $[3 \times C] \div J$ $[283.4 \times 1] \div 0.8 = 354.3 \text{ Ahr}$ |
| E. Conductor efficiency: 98% (0.98) | 5) $4 \div I$ $354.3 \div 148.8 = 2.38$ (rounded to 3) |
| F. Inverter efficiency: 90% (0.9) | 6) $[G \div H] \times 5$ $[12 \div 12] \times 3 \text{ strings} = 3 \text{ batteries}$ |
| G. System voltage: 12 Vdc | |
| H. Batteries: OutBack EnergyCell 200RE (12 Vdc) | |
| I. Capacity at 8-hour rate: 148.8 Ahr | |
| J. Maximum DoD: 80% (0.8) | |

Planning

EXAMPLE #2

A. Loads: 1 kW (1000 W)	1) $A \div [E \times F]$	$1000 \div (0.97 \times 0.93) = 1108.5 \text{ W}$
B. Hours of use: 3	2) $1 \div G$	$1108.5 \div 48 = 23.1 \text{ Adc}$
C. Days of autonomy: 1	3) $2 \times B$	$23.1 \times 3 = 69.3 \text{ Ahr}$
D. Off-grid system (FX3048MT inverter)	4) $[3 \times C] \div J$	$[69.3 \times 1] \div 0.5 = 138.6 \text{ Ahr}$
E. Conductor efficiency: 97% (0.97)	5) $4 \div I$	$138.6 \div 148.8 = 0.93$ (rounded to 1)
F. Inverter efficiency: 93% (0.93)	6) $[G \div H] \times 5$	$[48 \div 12] \times 1$ strings = 4 batteries
G. System voltage: 48 Vdc		
H. Batteries: OutBack EnergyCell 200RE (12 Vdc)		
I. Capacity at 8-hour rate: 148.8 Ahr		
J. Maximum DoD: 50% (0.5)		

Generator

- The FX inverter can accept single-phase input from a generator that delivers clean AC power in the range of voltage and frequency specified for that model.
 - ~ Inverters stacked for split-phase output (120/240 Vac) can work with both output lines of a split-phase generator. See pages 30, 32, and 36.
 - ~ Inverters stacked for three-phase output can work with three-phase generators. See page 38.
- The inverter/charger can provide a start signal to control an automatic start generator. If automatic generator starting is required, the generator must be an electric-start model with automatic choke. It should have two-wire start capability. For other configurations, additional equipment may be required.
- In any configuration, the inverter may need to be specifically programmed using the system display.  Perform all programming according to the specifications of the generator and the required operation of the inverter. Parameters to be programmed may include generator size, automatic starting requirements, and potential fluctuations in generator AC voltage.

Mobile generators are usually equipped with a bond between the neutral and ground connections. Mobile FX inverter models have neutral-ground switching. This function establishes a bond on the inverter when no generator is present, but removes it when the generator is running. See page 15 for more information on neutral-ground bonding.

Generator Sizing

A generator should be sized to provide enough power for all the loads and the battery charger. The generator size should assume maximum loads and maximum charging at the same time.

- Available generator power may be limited by ratings for circuit breakers and/or generator connectors.
- The generator must be able to provide current to all inverters on a given phase or output. Minimum generator size³ is usually recommended to be twice the power of the inverter system. For example, a 2 kVA inverter should have a 4 kVA (or larger) generator. Many generators may not be able to maintain AC voltage or frequency for long periods of time if they are loaded more than 80% of rated capacity.
- In addition, if a split-phase 120/240 Vac generator is powering a single-phase 120 Vac inverter system with no other compensation, it is **required** to be at least twice the power of the inverters. A split-phase generator that is heavily loaded on one output line may suffer severely from balancing issues. The OutBack FW-X240 or PSX-240 balancing transformers may compensate for this condition.



IMPORTANT:

In general, the generator output should match the stacking and output of the inverters. A three-phase generator should not be used with a 120/240 Vac inverter system. A purely 240 Vac generator will cause damage if used with a 120 Vac inverter system.

³ This is the generator size after derating for environment, use, and other factors.



Installation

Location and Environmental Requirements

Sealed (FX) models are resistant to water and other elements but are not designed for permanent outdoor installations. If installation on the outside of a vehicle is required, the FX inverter must be installed under cover and protected from direct exposure to the environment. Vented (VFX) models are not resistant to water and other elements. They must be installed in a weather-proof enclosure or enclosed area.

- The inverter can often be mounted in any position or orientation. If there is any exposure to moisture or condensation, the inverter must not be mounted upside-down. This ensures that water will not accumulate under the DC cover. However, it can still be mounted in other positions or orientations.
- For installations where the inverter may be exposed to moisture or condensation, a sealed model must be used and mounted either with the base down (shelf mounting) or with the AC wiring compartment facing down (wall mounting). If mounted with the base down, water cannot be allowed to accumulate around the inverter's base. There is a drainage system on the base of the inverter to dispel condensation. If submerged, water can enter this drain and cause failure.
- Vented inverters must be installed in a weather-proof enclosure or enclosed area. These models are not designed for exposure to water or excessive wind-blown dust and debris.
- When inverters are installed with an OutBack FLEXpower system, the system must be installed in the upright orientation due to the requirements of the circuit breakers.
- Any inverter will perform more efficiently in locations offering plenty of air circulation. The recommended minimum clearance is 2 inches (5 cm) on all sides of the inverter.
- Any inverter will function to all of its specifications if operated in a range of -4°F to 122°F (-20°C to 50°C).
- The inverter will function, but will not necessarily meet its specifications, if operated in a temperature range of -0°F to 140°F (-40°C to 60°C). This is also the allowable temperature range for storage.
- The FX series of inverters carry an Ingress Protection (IP) rating of 20 and a Relative Humidity (RH) rating of 93% (non-condensing).
- Inverter specifications are listed in the *FX Mobile Series Inverter/Charger Operator's Manual*.

Tools Required

- Wire cutters/strippers
- Torque wrenches
- Assorted insulated screwdrivers
- Digital voltmeter (DVM) or standard voltmeter

Installation

Mounting

- One person can install the FX inverter, but installation may be easier with two people.
- The unit has four mounting holes, one in each corner. Use fasteners in all corners for a secure installation.



IMPORTANT:

Use correct fasteners to secure the inverter to the mounting surface, regardless of the type of surface. OutBack cannot be responsible for damage to the product if it is attached with inadequate fasteners.

- Due to the variance in other mounting methods, OutBack only endorses the use of FLEXware mounting products or previous versions of OutBack mounting plates. Use M6 x 20 mm machine screws, one per corner, to attach the inverter to the mounting plate. Follow the instructions with each mounting system.
- Mount and secure each component before attaching any wiring.
- When the inverter is used with other metal chassis, make sure that all chassis are grounded appropriately. (See the grounding instructions on page 15.) Grounding other chassis may involve metal-to-metal contact, or separate ground wires.

If using an OutBack FLEXware Mounting Plate, avoid large air gaps behind the plate. These can result in louder mechanical noise during heavy inverting or charging. Mount the plate on a flat, solid mounting surface.

Dimensions

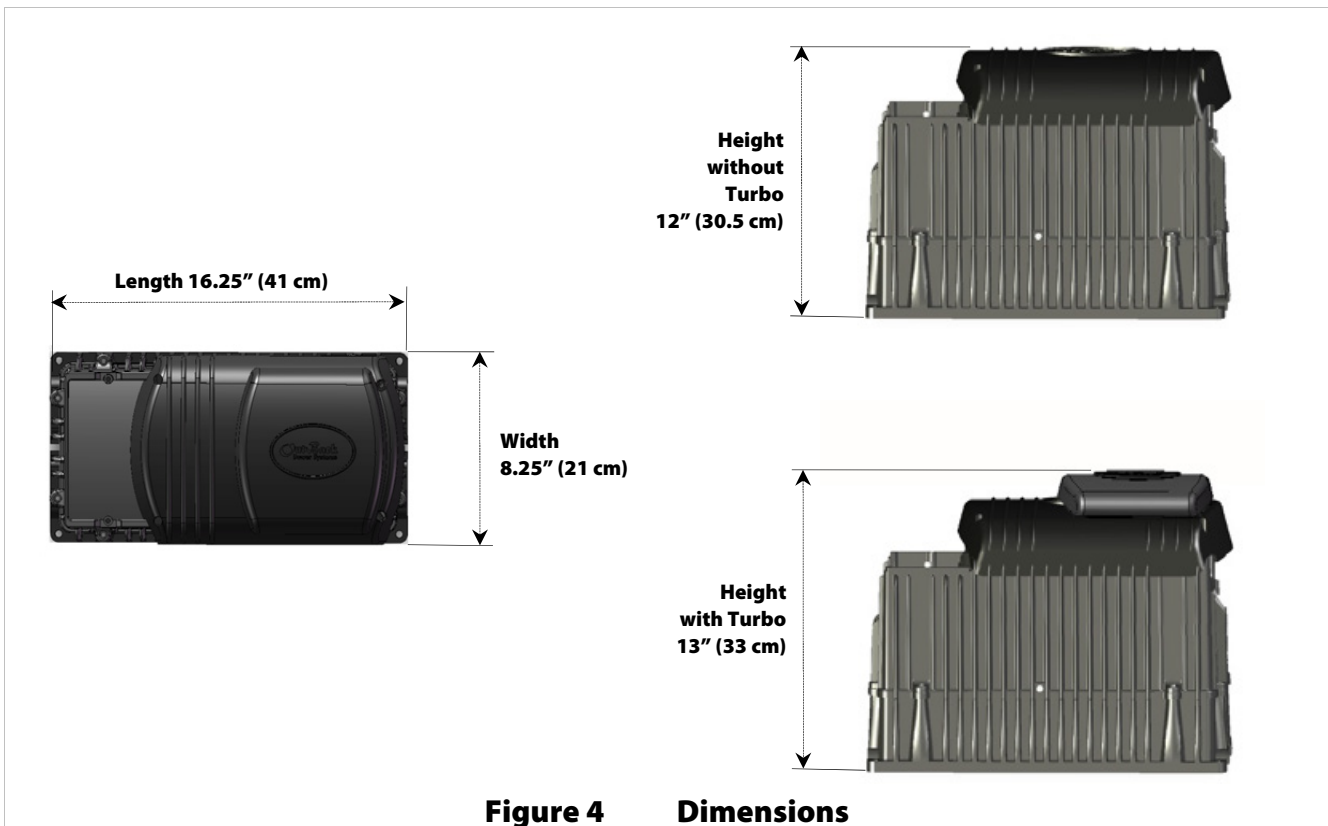

Terminals and Ports

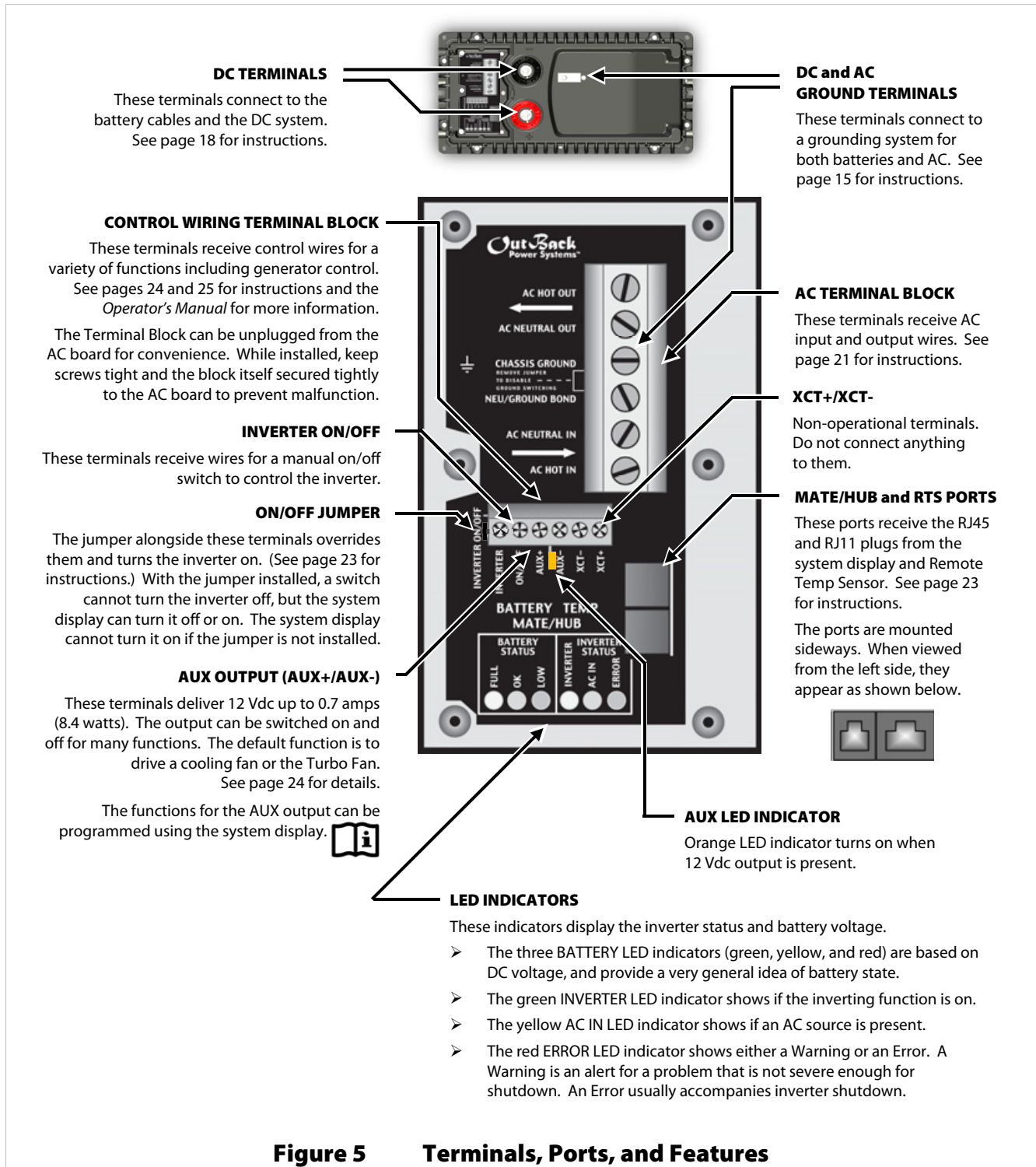

Figure 5 Terminals, Ports, and Features



WARNING: Shock Hazard

The inverter's AC output is defaulted to ON from the factory. It will deliver AC voltage as soon as the power is connected.

Installation

Wiring

It will be necessary to remove knockouts from the AC Plate to run wires. The AC Plate has one knockout of ½" size and two knockouts of ¾" size. Install appropriate bushings to protect the wires.

Use copper wire only. Wire must be rated at 75°C or higher.

Grounding



	<p>WARNING: Shock Hazard</p> <ul style="list-style-type: none"> ➤ Mobile models perform automatic neutral-to-ground bond switching. When this function is engaged, the chassis ground is electrically common with the output neutral conductor. When disengaged, the chassis ground is isolated from the AC system. See pages 17, 21, and 22. ➤ Make sure that no more than one bond is present in the AC system at any time.
	<p>WARNING: Shock Hazard</p> <p>For all installations, the negative battery conductor should be bonded to the grounding system at only one point. If the OutBack GFDI is present, it can provide the bond.</p>
	<p>IMPORTANT:</p> <p>Not all OutBack products can be used in a positive-ground system. If it is necessary to build a positive-ground system with OutBack products, contact OutBack Technical Support at +1.360.618.4363 before proceeding. Additionally, consult the online forum at www.outbackpower.com/forum/, where this subject has been discussed extensively.</p>

Table 3 Ground Conductor Size and Torque Requirements

Terminal Location	Minimum Conductor Size	Torque Requirements
Central AC Terminals	#10 AWG (0.009 in ²) or 6 mm ²	25 in-lb (2.8 Nm)
DC Box Lug	#6 AWG (0.025 in ²) or 16 mm ²	45 in-lb (5.1 Nm)

Table 3 contains OutBack’s recommendations for minimum safe cable sizes. Other codes for mobile or marine applications may supersede OutBack’s recommendations. Consult applicable codes for final size requirements.

The inverter's DC ground is a box lug located next to the negative DC battery terminal. This lug accepts up to 1/0 AWG (70 mm² or 0.109 in²) wire. Local codes or regulations may require the DC ground to be run separately from the AC ground. Also, if present, it will be necessary to remove the DC Cover or Turbo Fan before making the ground connection. (See page 20.)

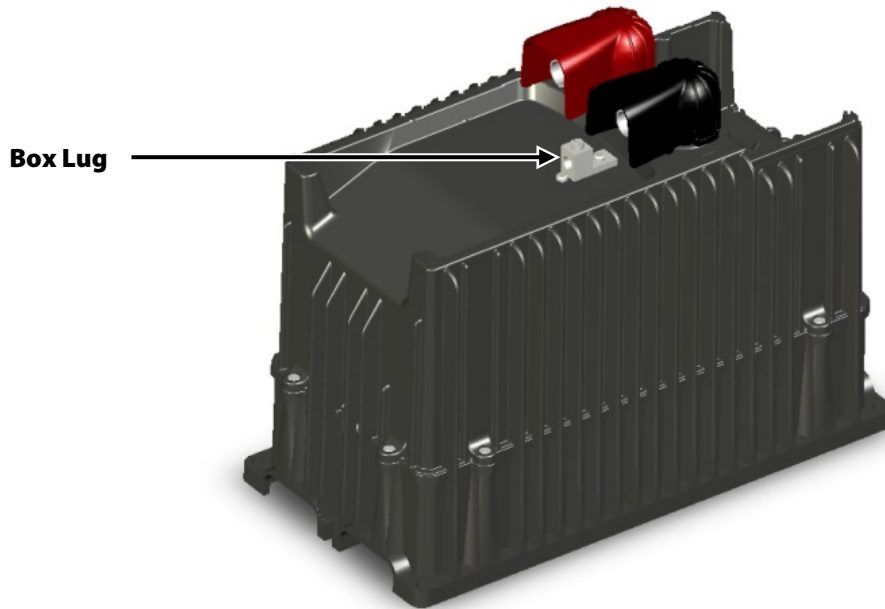

Figure 6 DC Ground Lug

One ground terminal is labeled CHASSIS GROUND. This terminal connects to an external ground bar or bus. The other terminal, labeled NEU/GROUND BOND, is not common with CHASSIS GROUND, but is joined to it by a copper jumper. No external connection is made to NEU/GROUND BOND.

- As long as the copper jumper is present, the FX inverter will automatically perform neutral-ground bond switching.
- If removed, the inverter's neutral and ground will be isolated.

If only one mobile inverter is present, leave the copper jumper in place.

If more than one mobile inverter is present, remove the copper jumper from every Slave unit.

See the inverter *Operator's Manual* for the general operation of neutral-ground bond switching. See page 22 for more information on the inverter's switching function.

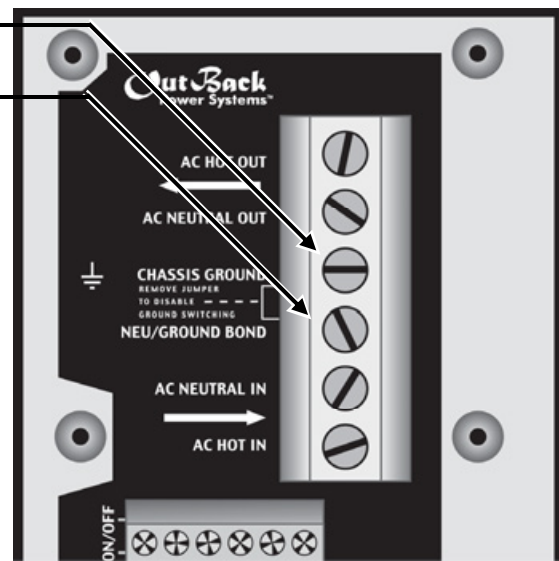

Figure 7 Chassis Ground

DC Wiring





	<p>WARNING: Shock Hazard</p> <p>Use caution when working in the vicinity of the inverter's battery terminals.</p>
	<p>CAUTION: Equipment Damage</p> <p>Never reverse the polarity of the battery cables. Always ensure correct polarity.</p>
	<p>CAUTION: Fire Hazard</p> <ul style="list-style-type: none"> ➤ The installer is responsible for providing overcurrent protection. Install a circuit breaker or overcurrent device on each DC positive (+) conductor to protect the DC system. ➤ Never install extra washers or hardware between the mounting surface and the battery cable lug. The decreased surface area can build up heat. See the hardware diagram on page 19.
	<p>IMPORTANT:</p> <ul style="list-style-type: none"> ➤ The DC terminals must be encased in an enclosure to meet the requirements of some local or national codes. ➤ Table 4 contains OutBack's recommendations for minimum safe cable sizes. Other codes may supersede OutBack's recommendations. Consult applicable codes for final size requirements.

Table 4 DC Conductor Size and Torque Requirements

Inverter (Wattage/Voltage)	Nominal DC Amps (Derated 125%)	Conductor Size ⁴ (Minimum)	Breaker Size (Minimum)
FX2012MT	200	4/0 AWG (120 mm ²) or 0.186 in ²	250 Adc
FX2024M	100	2/0 AWG (70 mm ²) or 0.109 in ²	175 Adc
FX2524MT	125	2/0 AWG (70 mm ²) or 0.109 in ²	175 Adc
FX2532MT	94	1/0 AWG (70 mm ²) or 0.109 in ²	125 Adc
FX2536MT	83	1/0 AWG (70 mm ²) or 0.109 in ²	125 Adc
FX3048MT	75	1/0 AWG (70 mm ²) or 0.109 in ²	125 Adc
VFX2812M	280	4/0 AWG (120 mm ²) or 0.186 in ²	300 Adc
VFX3524M	175	4/0 AWG (120 mm ²) or 0.186 in ²	175 Adc
VFX3232M	120	2/0 AWG (70 mm ²) or 0.109 in ²	175 Adc
VFX3236M	107	2/0 AWG (70 mm ²) or 0.109 in ²	175 Adc
VFX3648M	90	1/0 AWG (70 mm ²) or 0.109 in ²	125 Adc
Terminal Location		Torque Requirements	
Inverter DC Terminals		60 in-lb (6.9 Nm)	
Battery Terminals		See battery manufacturer's recommendations	

When installing DC cables:

- Battery positive and negative cables should be no longer than 10 feet (3 meters) each, to minimize voltage loss and other possible effects.
- Turn off DC circuit breakers or remove fuses before proceeding.
- Tie, tape, or twist cables together to reduce self-inductance. Run positive and negative cables through the same knockouts and conduit.
- The inverter's battery terminal is a threaded stud which accepts a ring terminal lug. Use crimped and sealed copper ring lugs with 5/16 inch (0.79 cm) holes, or use compression lugs.
- Install all overcurrent devices on the positive cable.

⁴ Cable sizes are for each inverter in a system. In a system with multiple inverters, each inverter requires its own cables and overcurrent devices of the size indicated.

To install DC cables and hardware:

1. Install all DC cables.
 - Do not install hardware in a different order from Figure 8. The battery cable lug should be the first item installed on the stud. It should make solid contact with the mounting surface.
 - Do not close the main DC disconnect until wiring is complete and the system is prepared for commissioning.

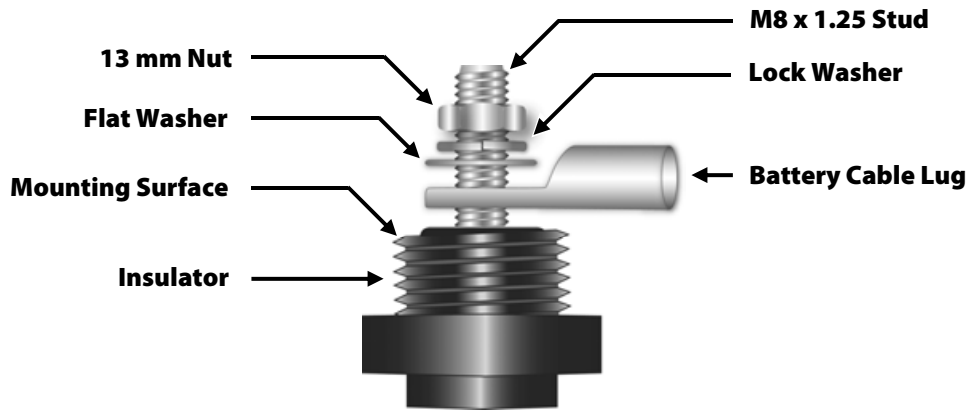

Figure 8 Required Order of Battery Cable Hardware



CAUTION: Fire Hazard

Never install extra washers or hardware between the mounting surface and the battery cable lug. The decreased surface area can build up heat.

2. Install the battery terminal covers. These are made of stiff plastic with a snap-on design.

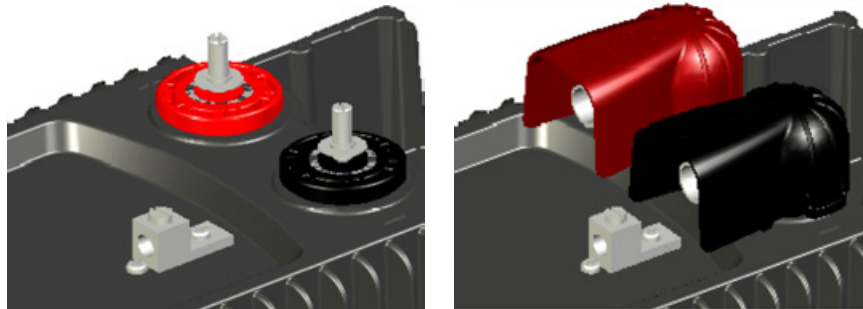

REMOVAL SLOT

If it is necessary to remove the covers, remove carefully using a flat screwdriver. Insert the screwdriver into the slot on the side of each cover and unsnap the cover..

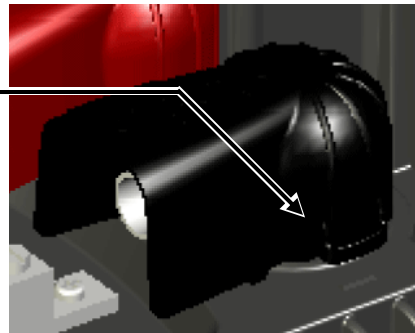

Figure 9 Battery Terminal Covers

DC Cover or Turbo Fan Attachment

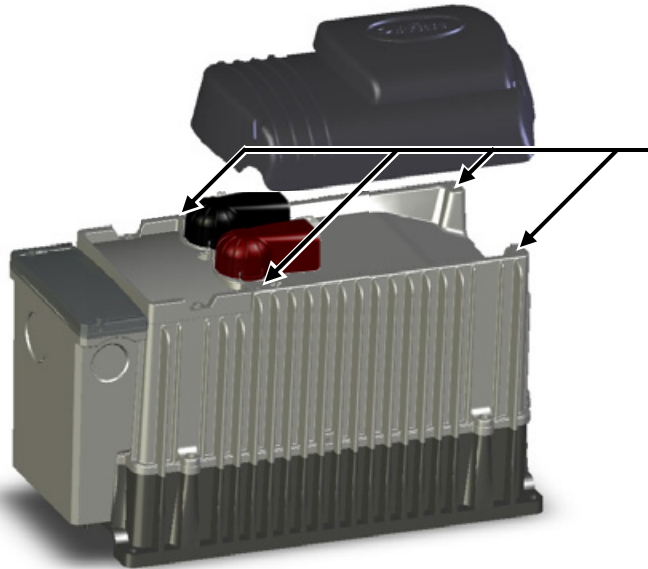

Figure 10 DC Cover Attachment

COVER ATTACHMENT

FX inverters are equipped with either the DC Cover or the Turbo Fan.

To attach either cover, put the cover in place. Insert a screw at each corner using a Phillips screwdriver.

As part of attaching the Turbo Fan, follow the wiring instructions in Figure 11.

TURBO FAN WIRING

Install the wires in the AC Wiring Compartment to make the Turbo Fan operational. The AUX+ and AUX- terminals receive the red (+) and black (-) wires. Tighten with a Phillips screwdriver.

To safely run the wires into the AC compartment, pass the wires through the notch in the compartment cover.

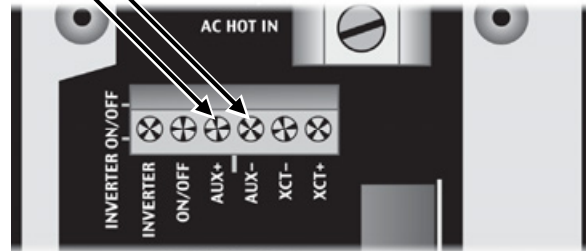

If necessary, the green terminal block can be unplugged by pulling it gently away from the AC board.

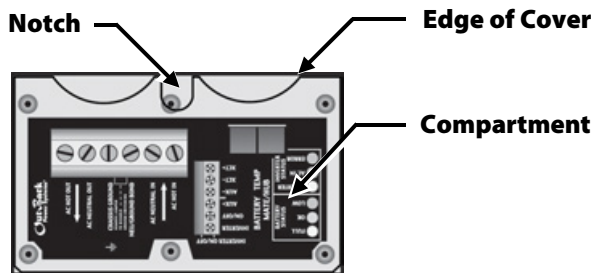





Make certain the AUX programming is correct for proper fan operation. 

Figure 11 Turbo Fan Wiring

If it is necessary to remove the Turbo Fan:

1. Remove the compartment cover.
2. Unscrew the AUX+ and AUX- terminal screws.
3. Remove the wires.
4. Remove the screws at the four corners of the Turbo Fan.
5. Remove the Turbo Fan.

AC Wiring

	<p>WARNING: Shock Hazard</p> <ul style="list-style-type: none"> ➤ All AC source neutral and ground conductors should be mechanically bonded. The inverter's neutral and ground conductors should be left isolated. The inverter performs automatic neutral-ground bond switching during operation. ➤ Ground fault circuit interrupter (GFCI) devices must be installed in a recreational vehicle wiring system to protect all branch circuits.
	<p>WARNING: Fire Hazard</p> <p>To reduce the risk of fire, do not connect to an AC load center (circuit breaker panel) having multi-wire branch circuits connected.</p>
	<p>IMPORTANT:</p> <ul style="list-style-type: none"> ➤ The installer is responsible for providing overcurrent protection. Install an approved 30 Aac circuit breaker on the inverter's output. ➤ This page contains OutBack's recommendations for minimum safe cable sizes. Other codes, particularly for mobile or marine applications, may supersede OutBack's recommendations. Consult applicable codes for final size requirements.

All system wiring must comply with national and local codes and regulations.

The inverter's AC terminal block has six positions for AC wires. The minimum recommended size is #10 AWG (6 mm²) or 0.009 in² wire. The terminals should be tightened to a torque value of 25 in-lb (2.8 Nm).

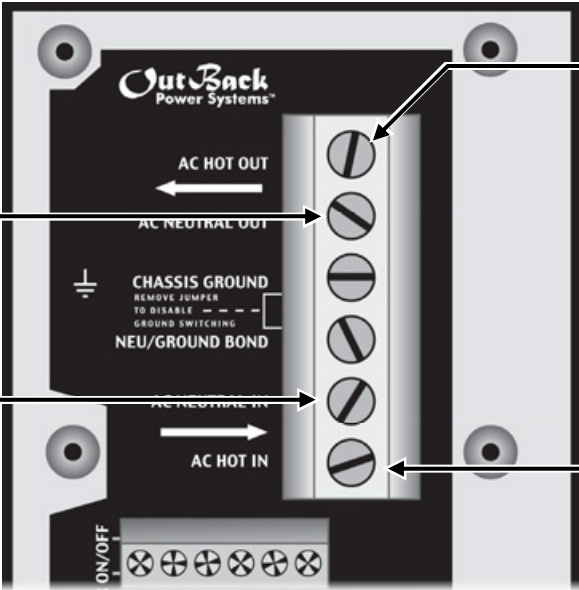

AC HOT OUT

The AC HOT OUT terminal connects to the output load panel. The terminal can carry up to 30 amps using the inverter's transfer relay. Use the inverter wattage to size the actual maximum output load. Size the circuit breaker accordingly.

AC HOT IN

The AC HOT IN terminal brings current from the AC source. It powers both battery charger and loads. Use the source size to determine actual current draw. Size all circuit breakers accordingly.

AC NEUTRAL OUT

The AC NEUTRAL OUT terminal connects to the neutral bus on the load panel.

AC NEUTRAL IN

The AC NEUTRAL IN terminal connects to the circuit breaker or bus from an AC input source, such as shore power or generator.

Do not connect the AC NEUTRAL IN and AC NEUTRAL OUT terminals together. These terminals are isolated from each other while inverting. When an AC source is connected, the neutral terminals switch to become electrically common.

The neutral bus from the input source must be kept isolated from the load panel's output neutral bus. Loads must not bridge the input and output terminals, even if the inverter does not power them. An example would be an air conditioner with its hot wire connected to the AC source and its neutral wire connected to the inverter's output load panel.

Figure 12 AC Terminals

Installation

AC Sources

The inverter has a single set of AC terminals which are intended to connect to a single AC source.

It cannot be directly wired to more than one AC source at the same time. If multiple sources are used, it is usually required to have a selector switch that changes from one to the next. The switch should be the “break before make” type which disconnects from one source before contacting another. It must also be a double-pole type which switches both the hot and neutral wires.

In mobile or marine installations, the AC source neutral and ground conductors are expected to be mechanically bonded.

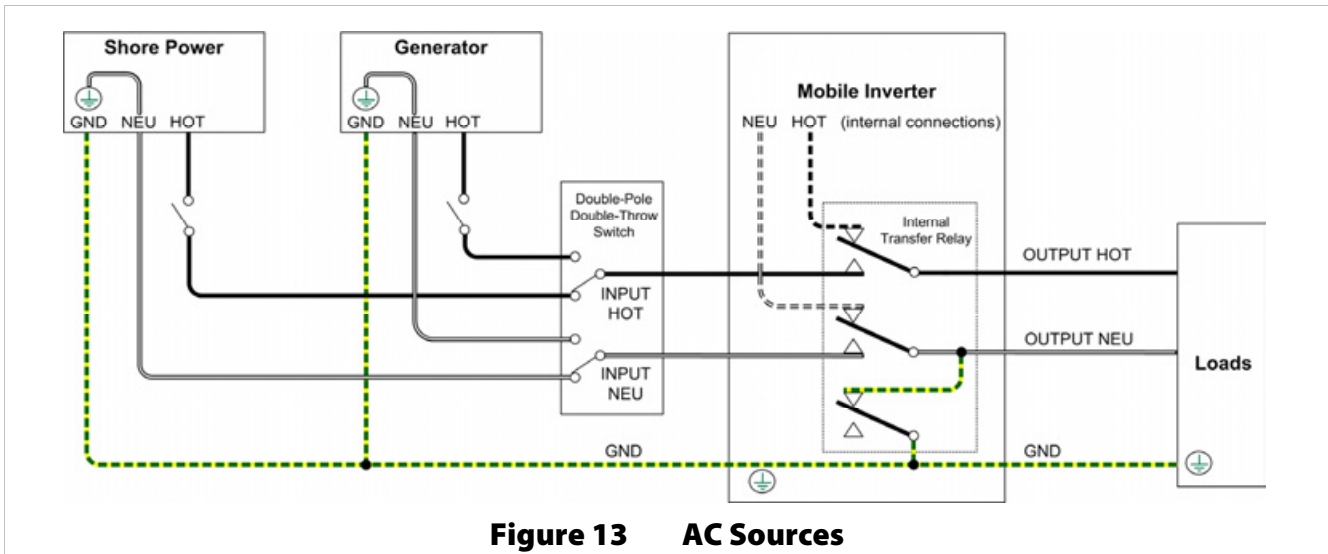

Figure 13 AC Sources

In Figure 13, the shore power and generator are disconnected. The internal transfer relay automatically bonds the inverter’s output neutral and ground connections as shown. This function can be disabled.

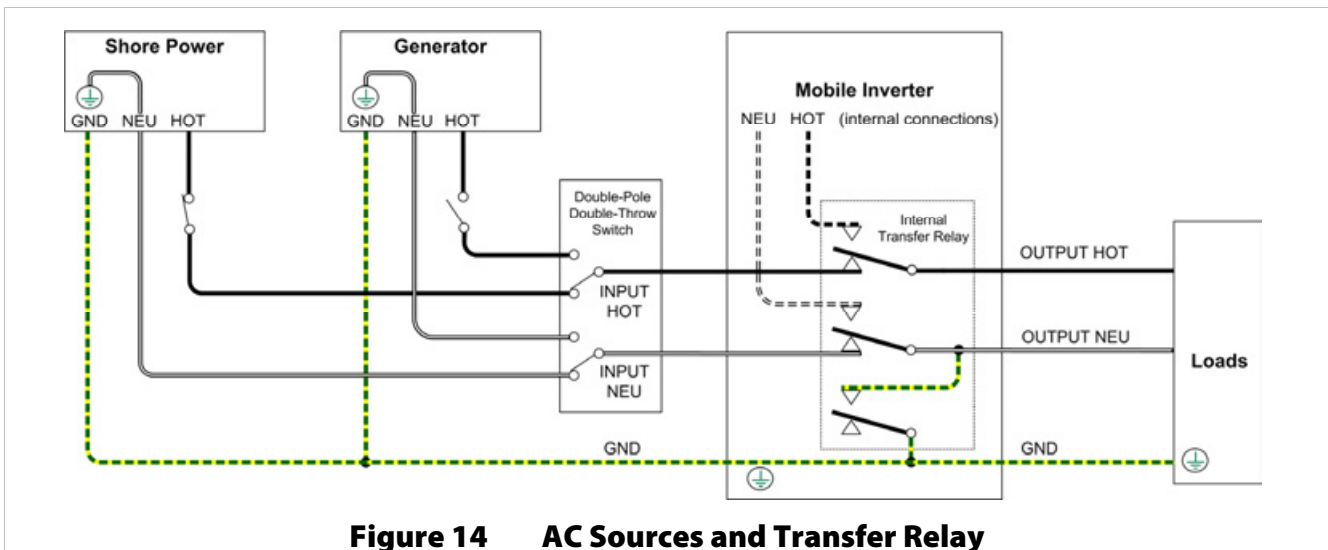

Figure 14 AC Sources and Transfer Relay

When either AC source is connected and accepted, the internal transfer relay switches to transfer the AC source power to the loads. The internal transfer relay also opens the internal neutral-ground bond. The AC Source bond is used instead. Figure 14 shows the shore power connected and shows the shore power bond.

See the *Operator’s Manual* for the inverter’s criteria for accepting an AC source.

ON and OFF Wiring

The INVERTER ON/OFF jumper bridges two pins. The ON/OFF jumper parallels the two INVERTER ON/OFF terminals on the Control Wiring Terminal Block. If either set of connections is closed, the inverter is ON. Because the jumper is factory-installed, the inverter usually remains ON unless given a command by the system display.

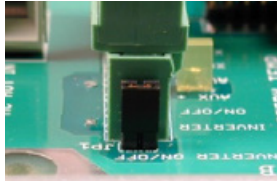

Jumper On

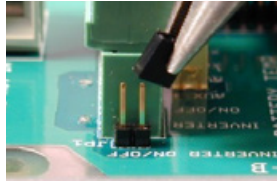

Jumper Off

Removing the jumper will turn the inverter OFF. This requires long-nose pliers or a similar tool.

Once the jumper has been removed, the INVERTER ON/OFF terminals on the Control Wiring Terminal Block can be used to wire a manual on/off switch.

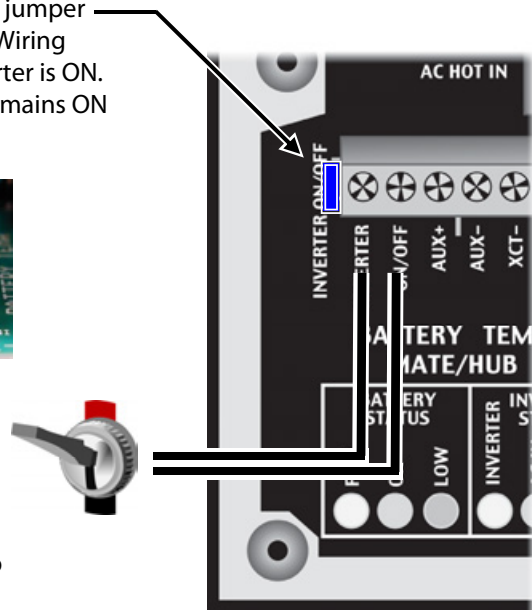

Figure 15 ON/OFF Jumper and Connections

Accessory Wiring

The AC Wiring Compartment Board has ports for both the Remote Temperature Sensor (RTS) and the system display. The system display port is labeled MATE/HUB.

If a HUB Communications Manager is in use, it occupies the inverter's MATE/HUB port.

RTS cable
RJ11,
4-conductor,
telephone)



MATE cable
RJ45, 8-conductor,
CAT5 non-crossover

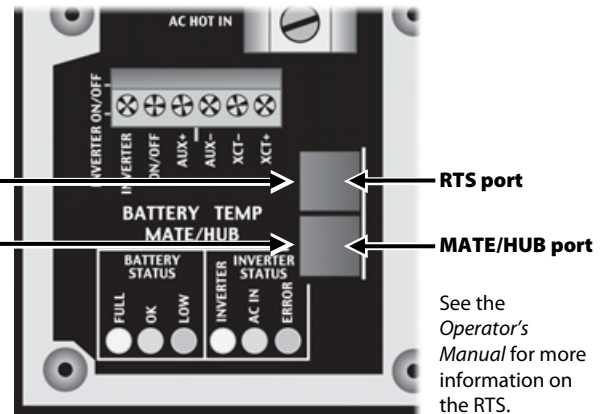

See the *Operator's Manual* for more information on the RTS.

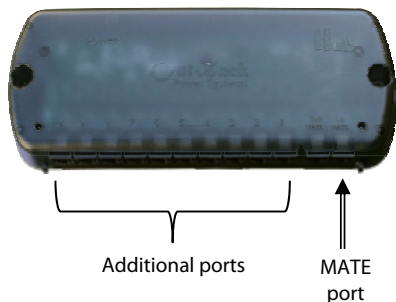

Additional ports

MATE port

When a HUB product occupies the inverter's MATE/HUB port, the system display connects directly to the HUB product. If the system display is a MATE2, do not connect it during initial startup. See the *MATE Owner's Manual* for more information. Inverters plug into ports 1 and above. Charge controllers and other devices plug into unassigned ports not used by inverters. See Stacking on page 28 for information on connecting inverters. See the HUB product literature for other devices.

Figure 16 Accessory Connections

AUX Wiring

The **AUX+** and **AUX-** terminals are a switched 12 Vdc supply. The **AUX** can respond to different criteria and control many functions. These include cooling fans, vent fans, load diversion, fault alarms, and the **Advanced Generator Start** (AGS) function.

The terminals can supply up to 0.7 amps at 12 Vdc (8.4 watts). This is sufficient to drive a small fan or a relay controlling a larger device. The terminals accept wire up to #14 AWG (2.5 mm²). The **AUX** circuit contains electronic overcurrent protection, which resets after being overloaded. No additional fuses are required for the **AUX** terminals.

The default setting for the **AUX** output is to control the Turbo Fan included with sealed models.

(See Figure 17.) The **AUX** output can only control one function at a time. It cannot be used for anything else if the Turbo Fan is connected.

The control logic for the **AUX** output is not always located in the same device. Inverter **AUX** functions are located within the inverter itself and are described accordingly. Although inverter-based functions require the system display for programming, they will function even if the display is removed. However, AGS programming is located within the system display and will not work if the display is removed. Other devices may also be able to control the terminals. For generator control, see page 25.

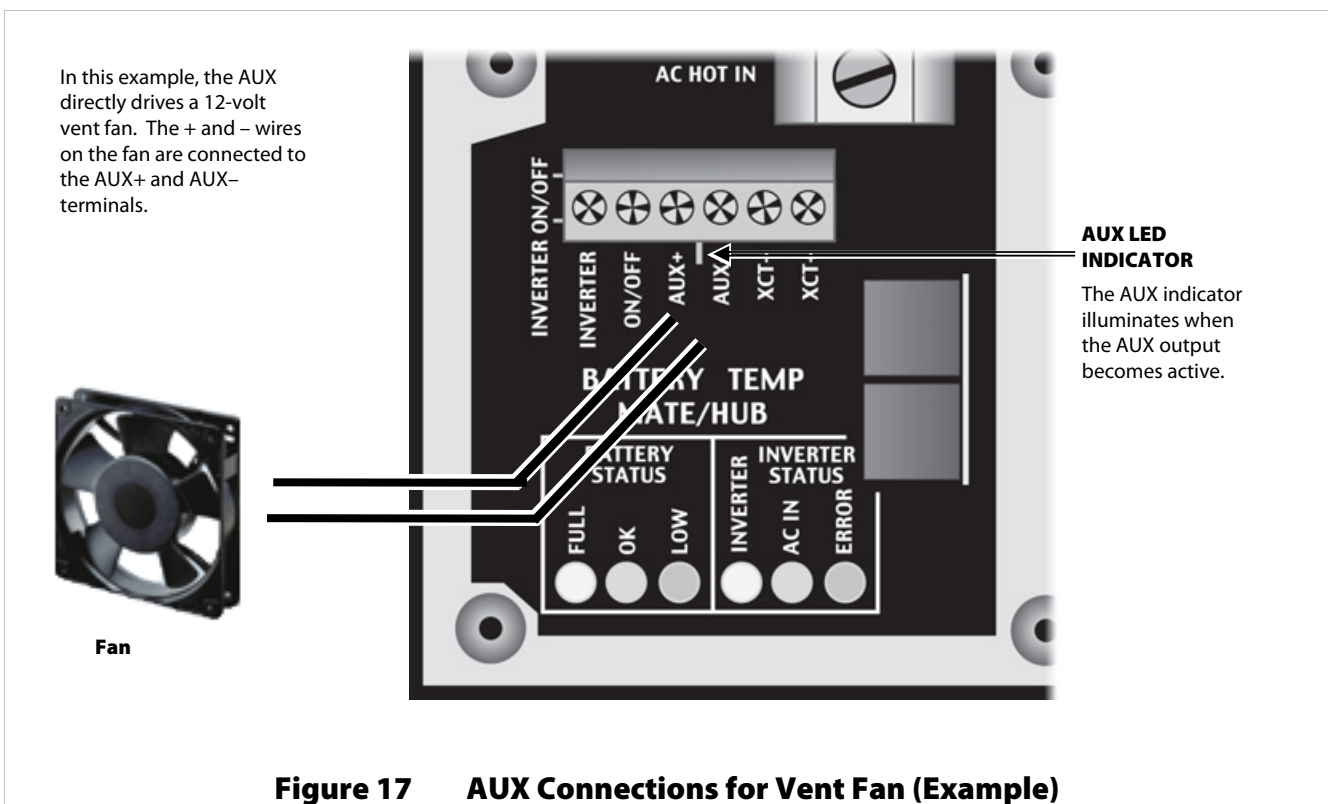

Generator Control

The AUX terminals can provide a signal to control an automatic-start generator. The control function can be **Advanced Generator Start** (AGS), which is situated in the system display. AGS can start the generator using settings from the system display, or it can use battery readings from the FLEXnet DC battery monitor. Alternately, the control function can be **Gen Alert**, which is a simpler function based directly in the FX inverter. The choice of control function depends on system needs and the capabilities of each device.

The generator must be an electric-start model with automatic choke. It is recommended to have “two-wire” start capability. A two-wire-start generator is the simplest type, where the cranking and starting routine is automated. It usually has a single switch with two positions that is turned ON to start, OFF to stop.

Two-Wire-Start

The 12 Vdc signal provided by the **AUX** output can be switched on and off to provide a start signal. It is possible to send a 12-Vdc signal directly to the generator. However, this should never be done if it connects the **AUX** output directly to the generator’s own battery. It is more common to use the **AUX** terminals to energize the coil of a 12 Vdc automotive or similar relay.

OBR-16-DIN, the OutBack FLEXware Relay Assembly depicted in Figure 18, is sold for this purpose. The relay contacts can serve in place of the generator’s start switch. The battery shown below is depicted for clarity. In most cases, it is part of the generator’s internal starting circuit and is not an external component.

The drawing below is one example of a possible arrangement. Specific arrangements, relays, and other elements depend on the requirements of the installation and of the generator.

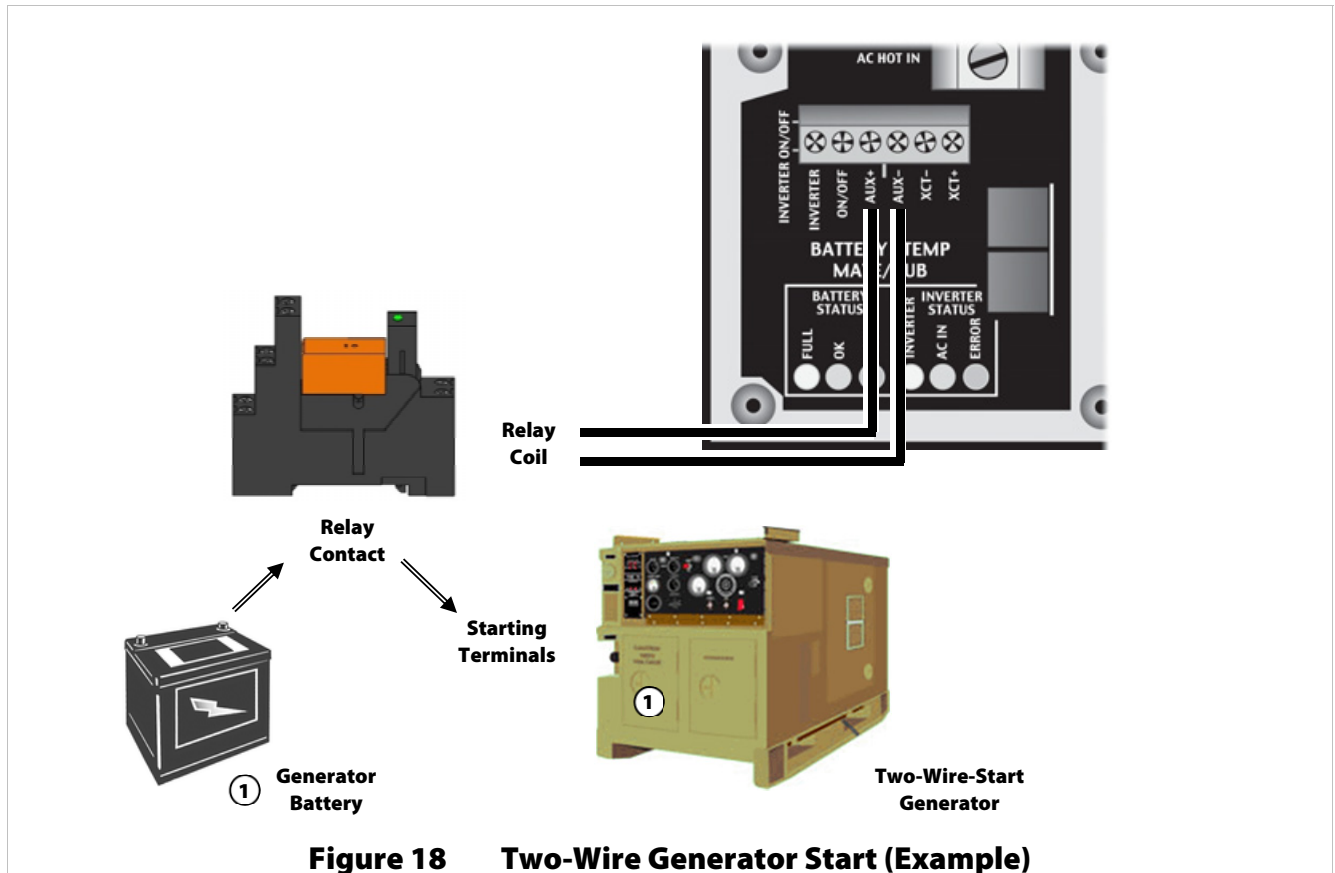

Installation

Three-Wire-Start

A “three-wire-start” generator has two or more starting circuits. It usually has a separate switch or position for cranking the generator. A three-wire generator has fewer automated functions than a two-wire. It usually requires multiple controls for starting, running, or stopping. The AUX terminals cannot control this type of generator without using a three-wire to two-wire conversion kit.

Atkinson Electronics (<http://atkinsonelectronics.com>) is one company that makes these kits. The Atkinson GSCM-Mini is intended to work with OutBack inverters.

The drawing below is one example of a possible arrangement. Specific arrangements, relays, and other elements depend on the requirements of the installation and of the generator.

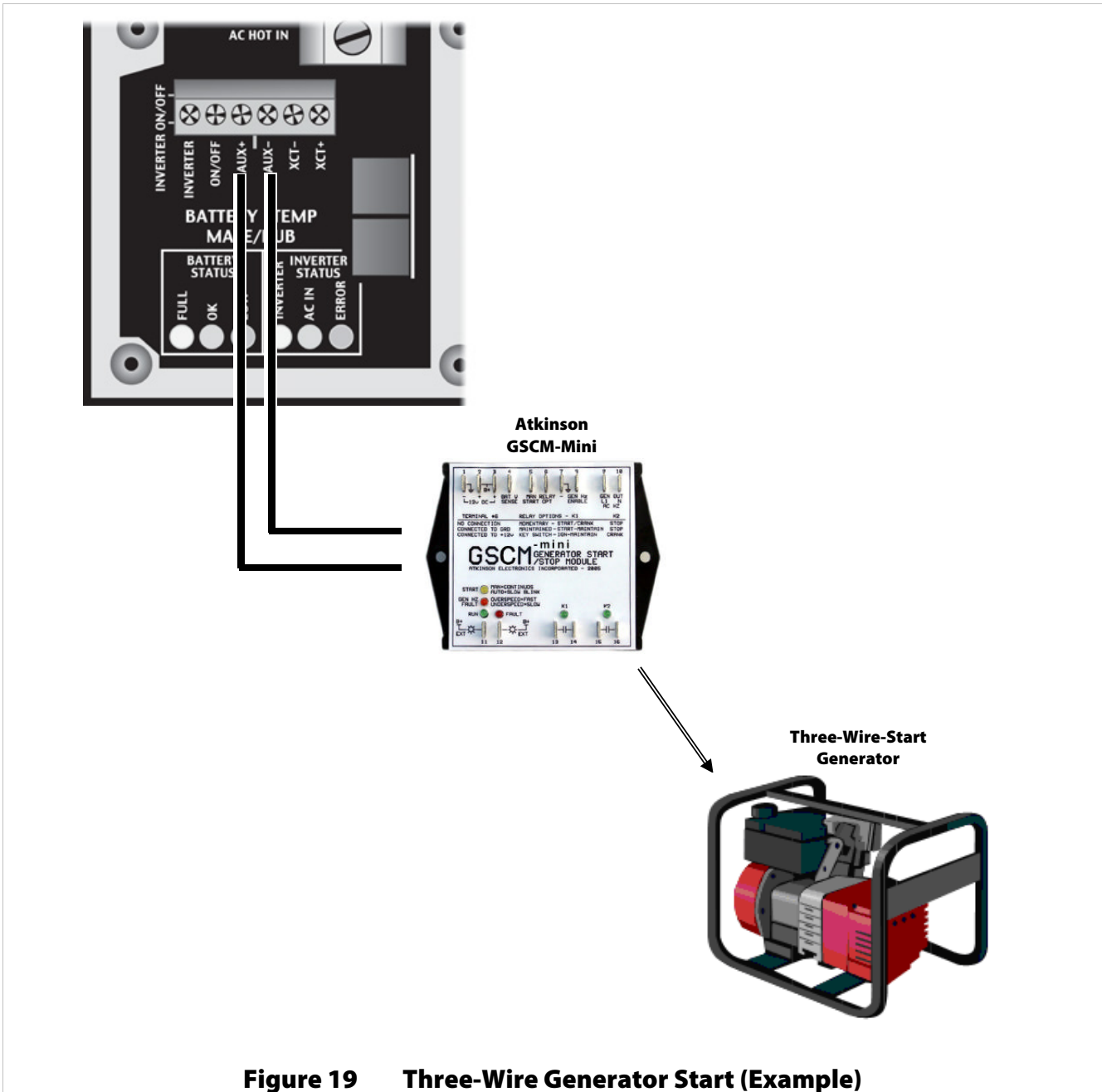

AC Configurations

Single-Inverter

When installing an inverter AC system, the following rules must be observed.

- All overcurrent devices must be sized for 30 Aac or less.
- All wiring must be sized for 30 Aac or more.
- All output circuit breakers must be sized appropriately for loads and inverter power.
- The AC input (generator or utility grid) must be a single-phase source of the proper voltage and frequency.

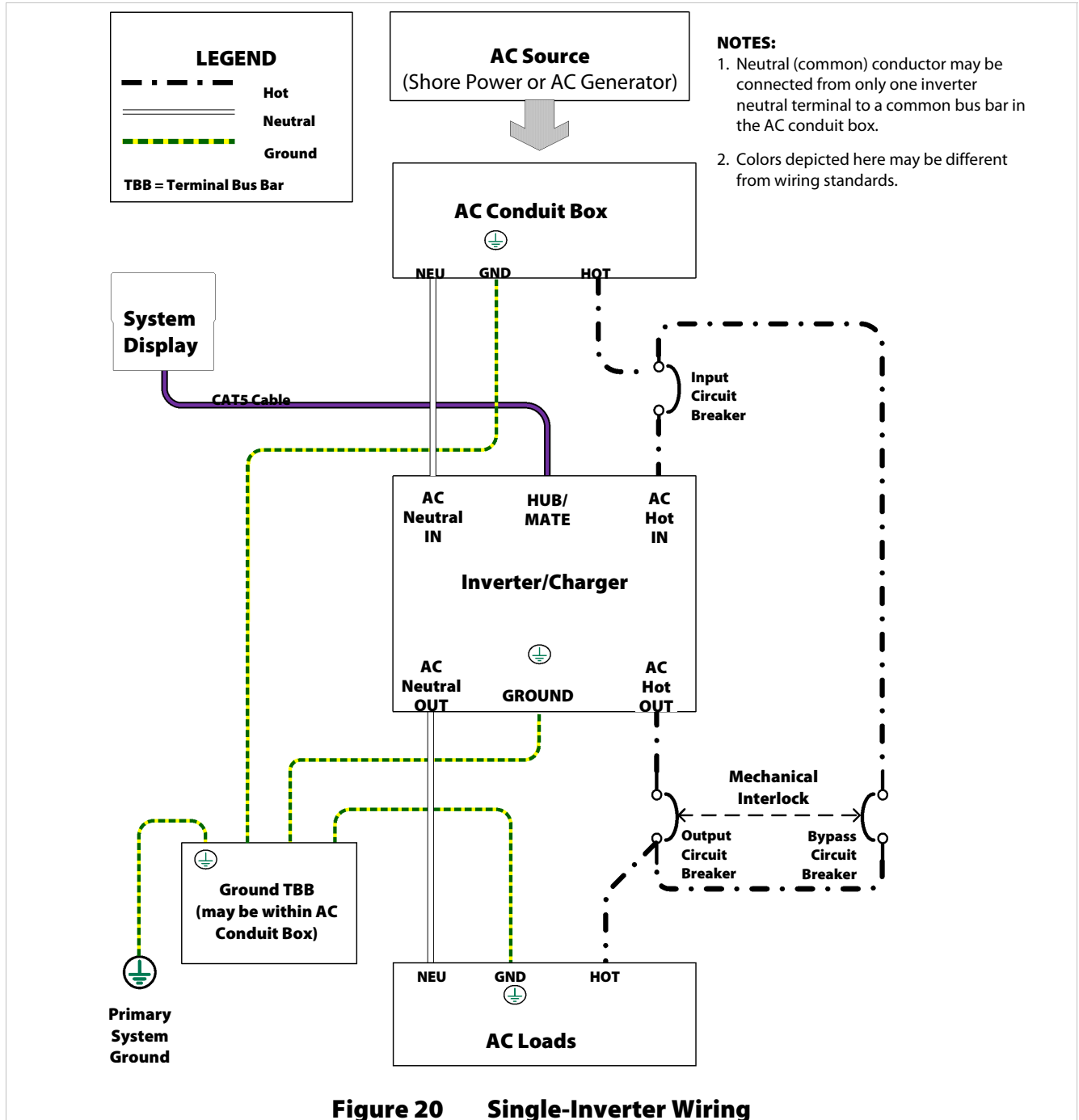

Figure 20 Single-Inverter Wiring

Installation

Multiple-Inverter AC Installations (Stacking)

Installing multiple inverters in a single AC system allows larger loads than a single inverter can handle. This requires stacking. Stacking inverters refers to how they are wired within the system and then programmed to coordinate activity. Stacking allows all units to work together as a single system.

Examples of stacking configurations include “classic series”, “OutBack series”, “parallel”, “series/parallel”, and “three-phase” configurations.

Stacking Connections

Stacking requires an OutBack communications manager and a system display.

- If the MATE or MATE2 System Display is used, it must have firmware revision 4.1.6 or above.
- A system of four or fewer units may use the HUB4 Communications Manager.
- A system of up to ten units requires the HUB10.3 Communications Manager.
- All interconnections between the products are made using CAT5 straight-through (non-crossover) cable.

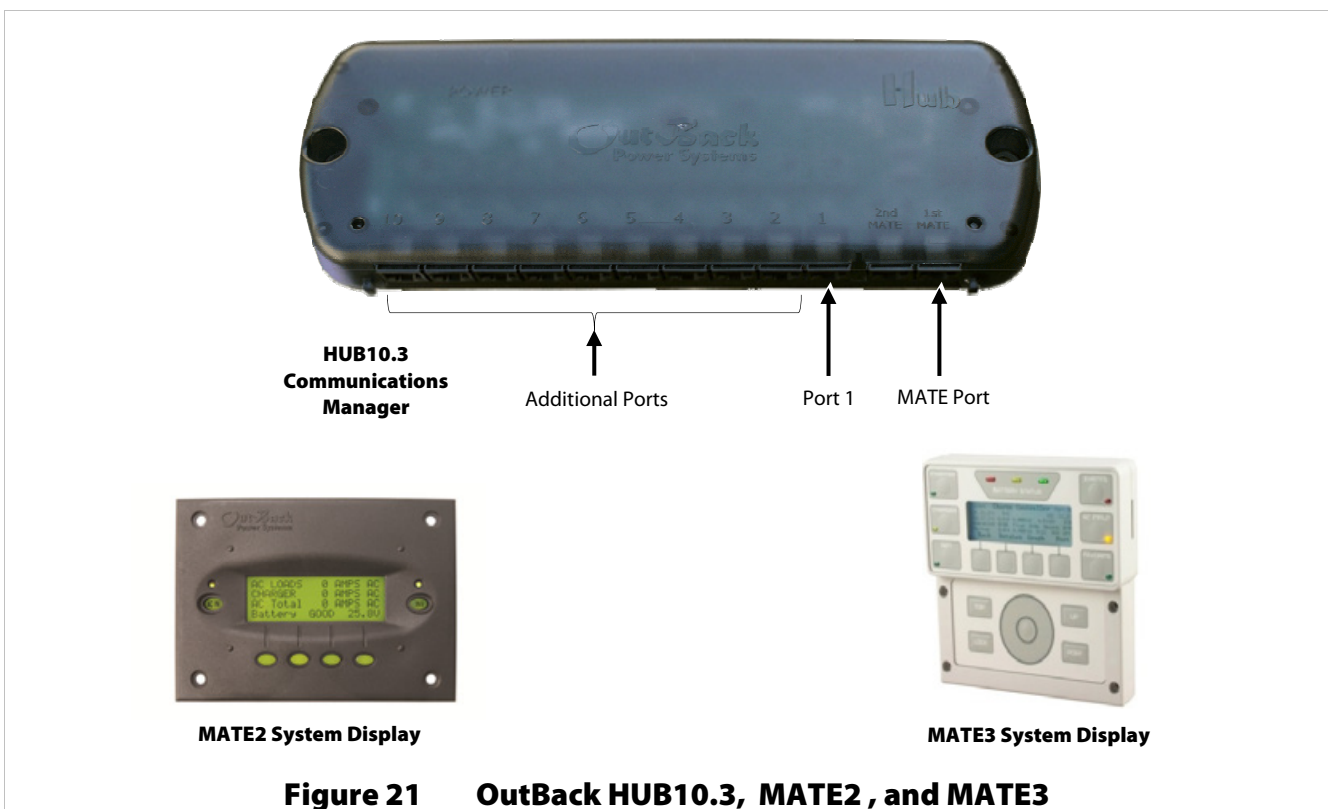

Each inverter must be assigned a stacking mode depending on the configuration. Modes are described below. Mode names sometimes vary with inverter model; see Table 5 on page 29.

- The master provides the primary output phase. Other inverters in the system base their phase on that of the master. If the master shuts off, all other inverters also shut off. The master must sense and connect to an AC source before other inverters can connect.
 - ~ In all cases, the master inverter must be connected to port 1 on the communications manager.
 - ~ In a parallel-stacked or OutBack-stacked system, the master tends to be the most heavily used unit.
 - ~ The selection for three-phase master is different from the single-phase master.

There are two types of slave modes. The names used here are derived from their references onscreen.

- A “classic” slave is used for stacking when the slave operates semi-independently of the master. Although the master sets the phase relationship, the slave creates an output independent of the master. It is not possible to balance the outputs with the FW-X240 transformer using this method. This type of system is used for the most basic form of series stacking (two inverters only) and for three-phase stacking.
 - ~ Classic-stacked inverters can go into Search mode independently of the master if necessary.
- An “OutBack” slave is used for parallel or series/parallel systems. In parallel stacking, all slaves are in phase with the master. In series/parallel systems, some slaves are in phase with the master and some are 180° out of phase. The FW-X240 autoformer can balance the loads of OutBack-stacked inverters.
 - ~ All slave outputs are pulse-width-matched to be precisely synchronized with the master inverter. This avoids potential backfeed situations.
 - ~ OutBack slaves can be placed in Power Save mode when not in use. They are activated by the master inverter as needed. For this reason, the master is normally the only inverter to enter Search mode. See the *Operator’s Manual* for descriptions of Power Save and Search mode.

In many cases the port assignments for secondary inverters (ports 2 to 4 or 2 to 10) is important. In general it is always important to keep track of units and ports for programming purposes. See the communications manager and system display literature for more information.

Programming involves using the system display to assign a status and stacking value to the inverter on each port. Each inverter is assigned to power a specified phase of the system. These assignments can be changed at any time as long as the master is plugged into port 1.



IMPORTANT:

- The master inverter must always be connected to port 1 on the communications manager. Connecting it elsewhere, or connecting a slave to port 1, will result in backfeed or output voltage errors which will shut the system down immediately.
- Installing multiple inverters without stacking them (or stacking them incorrectly) will result in similar errors and shutdown.
- Although stacking allows greater capacity, the loads, wiring, and overcurrent devices must still be sized appropriately. Overloading may cause circuit breakers to open or the inverters to shut down.
- Table 5 shows all applicable modes for each inverter model.

Table 5 Stacking Modes for Mobile FX Inverters

Mode Name (MATE3 or MATE)	When Used	Function
1-2phase Master or 1-2ph Master	Classic stack , OutBack stack	Master inverter for all series and parallel stacking
Classic Slave	Classic stack (series) ⁵	Slave inverter for Classic series stack
OB Slave L1	OutBack stack (parallel or series/parallel)	Slave inverter (in phase with master) for parallel stack
OB Slave L2	OutBack stack (series or series/parallel)	Slave inverter (out of phase with master) for OutBack series stack
3phase Master or 3ph Master	Three-phase stack ⁶	Phase A inverter for three-phase stack
3phase Slave or 3ph Slave	Three-phase stack ⁶	Phase B or C inverter (phase is assigned by port) for three-phase stack

⁵ Two inverters only

⁶ Three inverters only

Stacking Configurations

Classic Series Stacking (Dual-Stack)

In series stacking, two inverters create two separate 120 Vac output phases. One inverter is the master. The other is a slave that is intentionally 180° out of phase with the master. Each of these outputs can be used to power a separate set of 120 Vac loads. Collectively they form a “split-phase” configuration which produces 240 Vac. “Classic” series stacking is the simplest way to achieve this output.

- The two outputs operate independently of each other. The 120 Vac loads on each output cannot exceed a given inverter’s size. The second inverter cannot assist.
- Only two inverters, one per output, may be classic series stacked. They must be the same model.

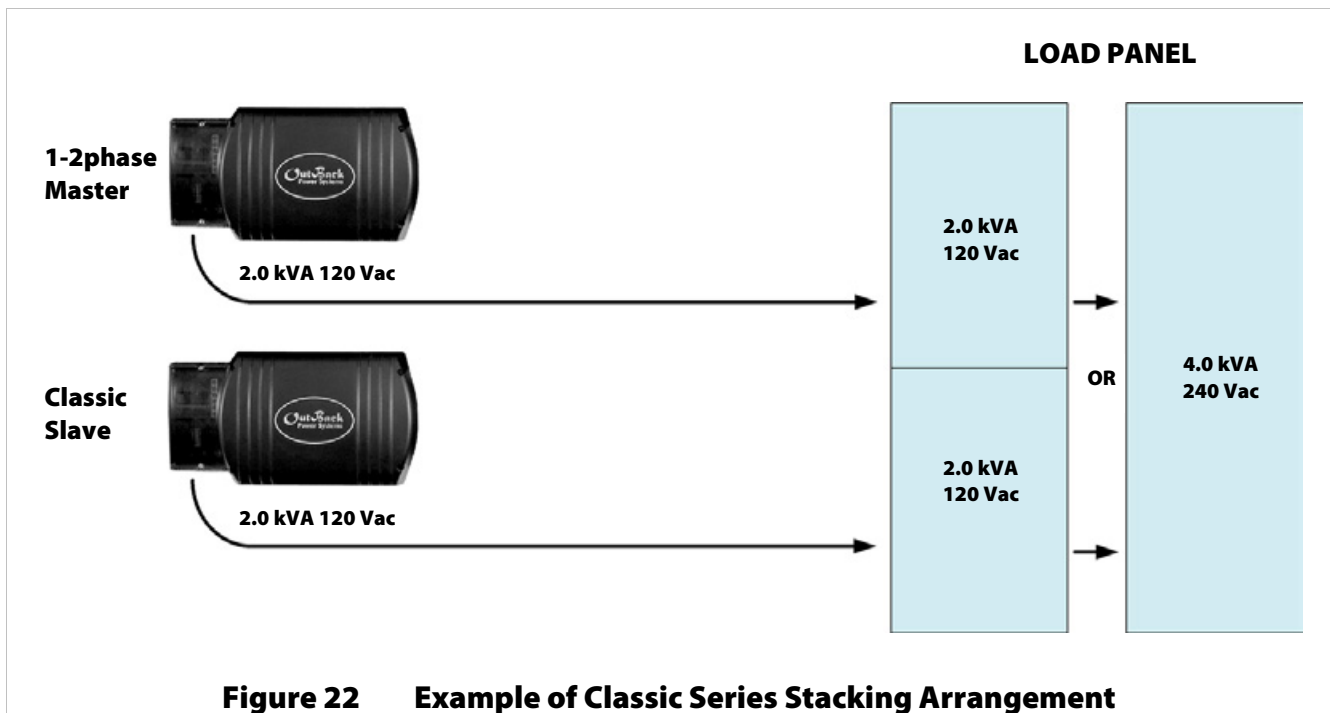

When installing a series inverter system, observe the following rules.

- Series stacking requires both a system display and a communications manager. Port assignments and jumper positions vary with model and stacking configuration. 
- The master inverter is the L1 output. It must be connected to communications manager port 1. It is programmed as **1-2phase Master**. Other inverters must not be selected as master.
- The L2 inverter must be programmed as **Classic Slave** during programming. See the HUB Communications Manager literature for port assignments.
- All overcurrent devices must be sized for 30 Aac or less. All wiring must be sized for 30 Aac or more.
- All output circuit breakers must be sized appropriately for loads and inverter power.
- The AC input (generator or shore power) must be 120/240 Vac (split-phase).

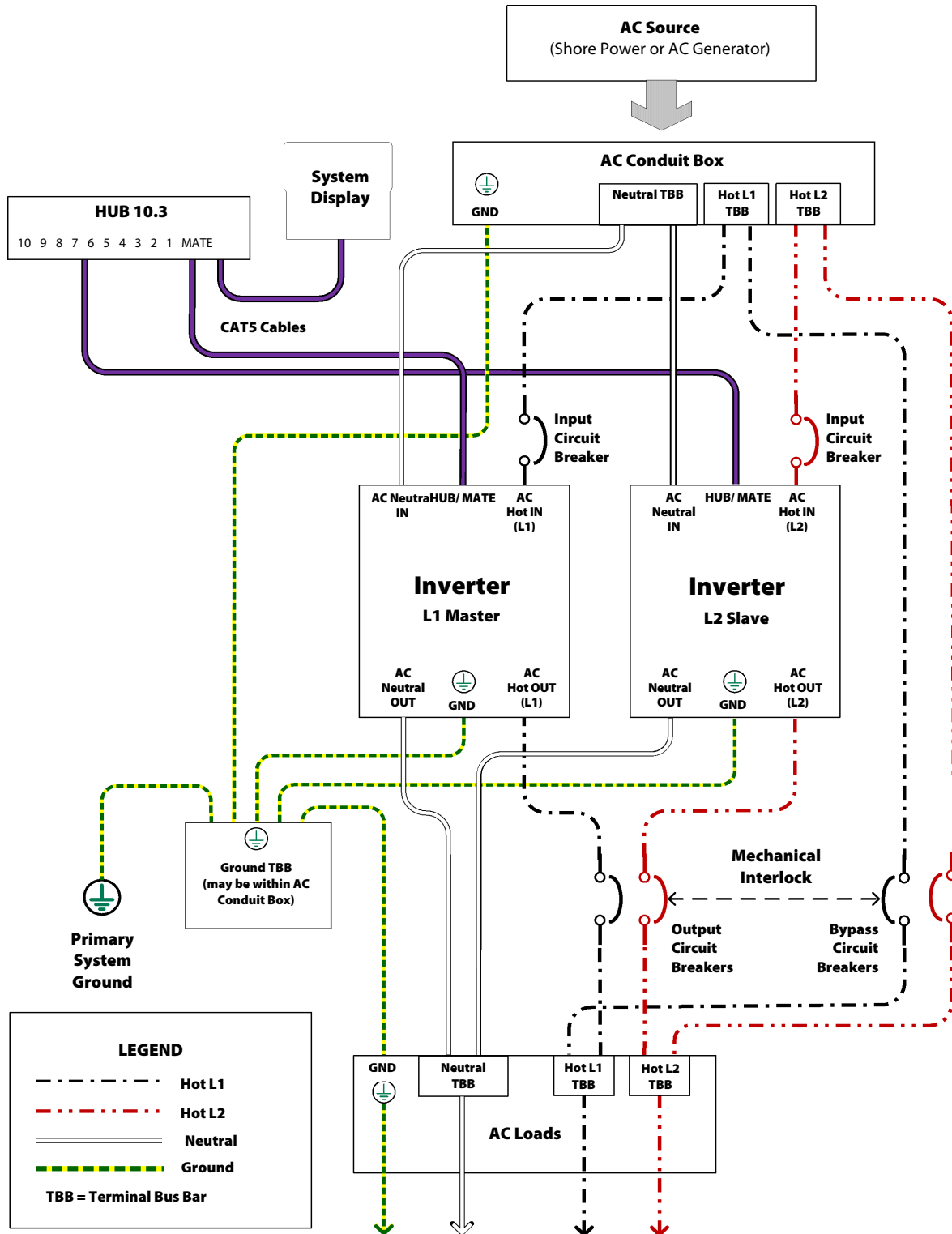

NOTES:

1. Neutral (common) conductor may be connected from only one inverter neutral terminal to a common bus bar in the AC conduit box.
2. Colors shown here may be different from wiring standards.

Figure 23 Classic Series Wiring

OutBack Series Stacking (Dual-Stack)

In OutBack's unique series stacking, two inverters create a "split-phase" configuration. This configuration creates two separate 120 Vac output legs. One output is the master. The other is a slave that is intentionally 180° out of phase with the master. The collective voltage is 240 Vac, as in Classic stacking. However, the output loads are balanced with the FW-X240 autotransformer.

- The slave output is controlled directly by the master and cannot operate independently.
- In the event of a load imbalance in a 120/240 Vac system, the FW-X240 transformer can transfer power from one output to the other. The transfer balances the loads on each inverter. It also allows heavy 120 Vac loads on either leg to use the full power of both inverters. (The loads below are marked "2+ kVA" per output. This means the power of a 2 kVA inverter is assisted by the other output.)
- The slave can go into Power Save mode when not in use. The FW-X240 autotransformer allows the master to power loads on either output. This reduces idle power consumption and improves system efficiency.
- Additional inverters can be added for combination series/parallel operation. See page 36. All inverters must be the same model.

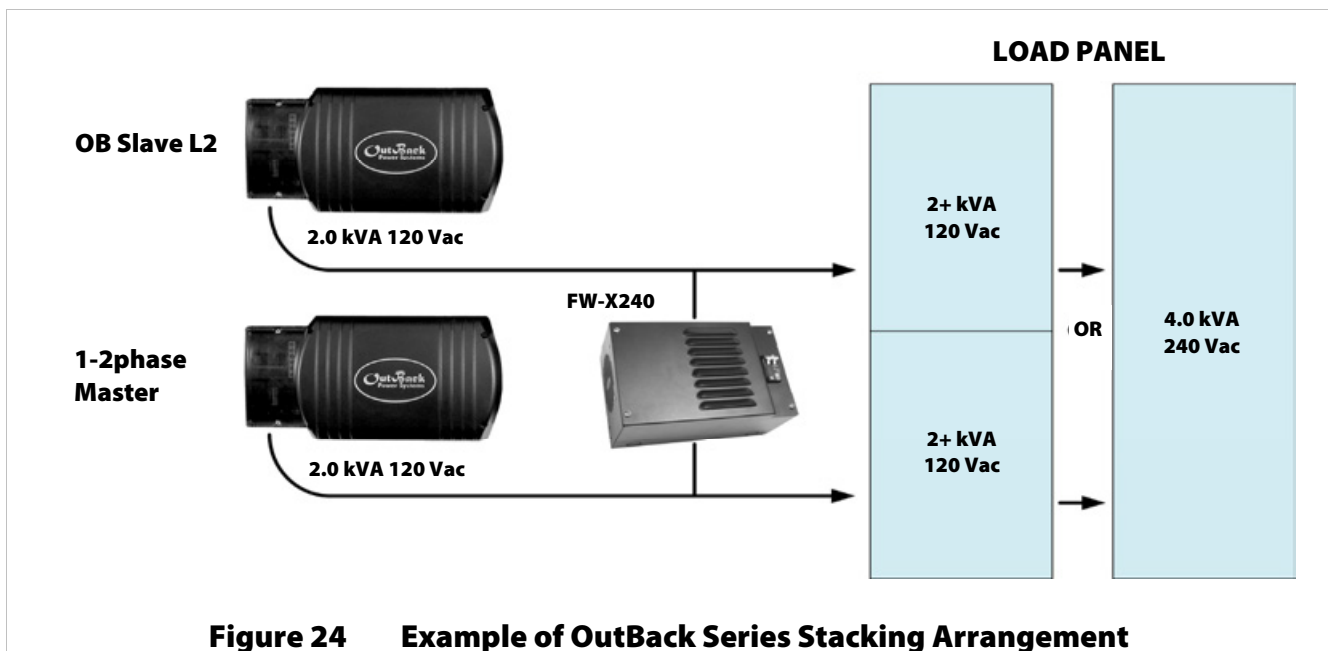



Figure 24 Example of OutBack Series Stacking Arrangement

When installing an OutBack series system, the following rules must be observed.

- Series stacking requires an FW-X240 autotransformer, a system display and a communications manager. Port assignments and jumper positions vary with model and stacking configuration. 
- The inverter that is mounted physically lowest is designated as the master. It is the L1 output. Mounting the master below the other inverters allows the master to avoid heat buildup and remain relatively cool.
- The master must be connected to communications manager port 1. It is programmed as **1-2phase Master**.  Other inverters must not be selected as master.
- The L2 inverter must be programmed as **OB Slave L2** during programming. See the HUB Communications Manager literature for port assignments.
- All overcurrent devices must be sized for 30 Aac or less. All wiring must be sized for 30 Aac or more.
- All output circuit breakers must be sized appropriately for loads and inverter wattage.
- The AC input (generator or shore power) must be 120/240 Vac (split-phase).

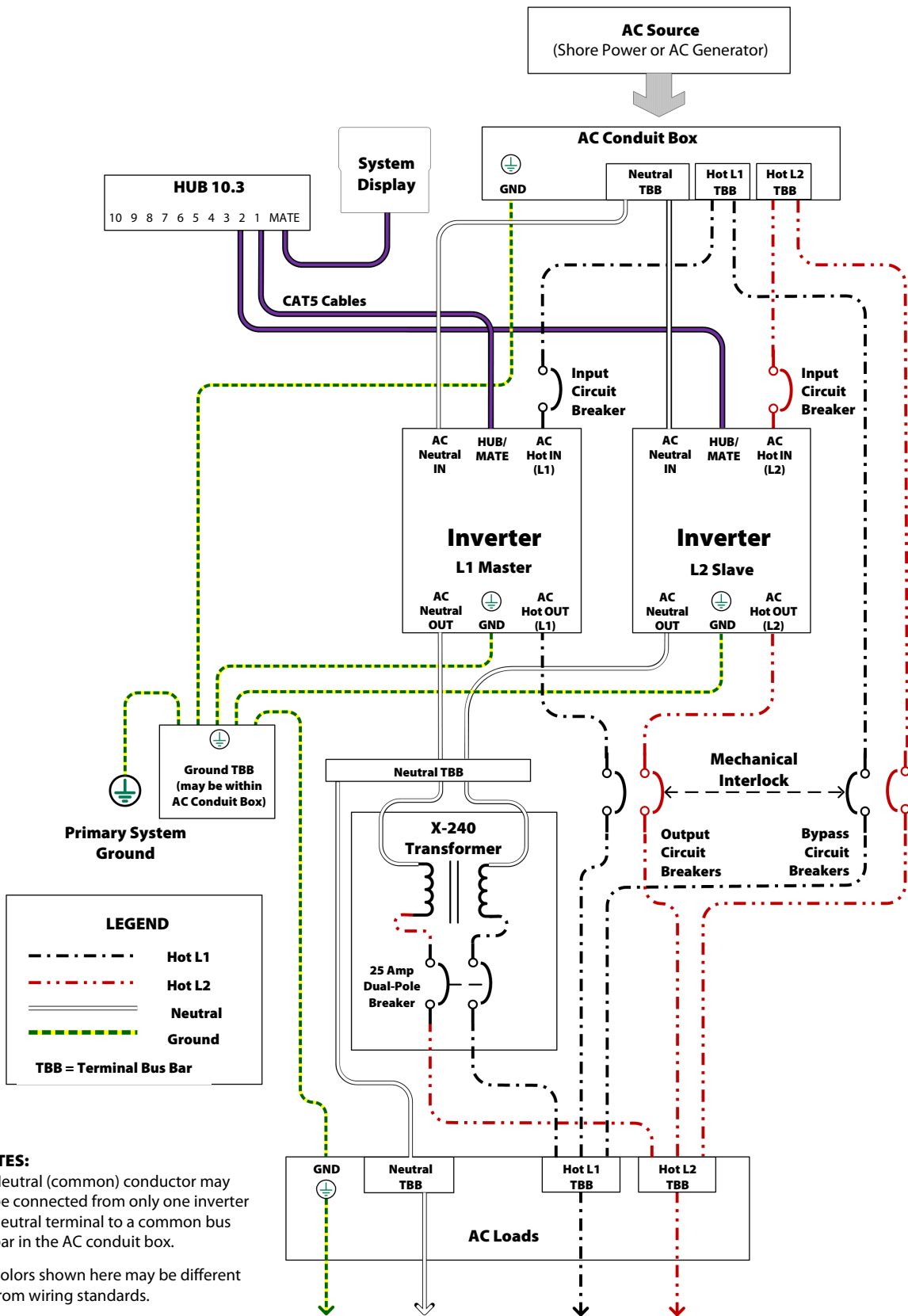

Figure 25 OutBack Series Wiring (Two Inverters)

Parallel Stacking (Dual-Stack and Larger)

In parallel stacking, two or more inverters create a single, common 120 Vac bus.

- All inverters share a common input (AC source). The inverters run loads on a common output bus. The master inverter provides the primary output. The slaves are connected to the same output and assist the master.
- The slave outputs are controlled directly by the master and cannot operate independently.
- Slave inverters can go into Power Save mode when not in use. The master will activate individual slaves based on load demand. This reduces idle power consumption and improves system efficiency.
- Up to ten inverters may be installed in a parallel arrangement. The example on this page shows three inverters. The wiring diagram on the next page shows four. All inverters must be the same model.

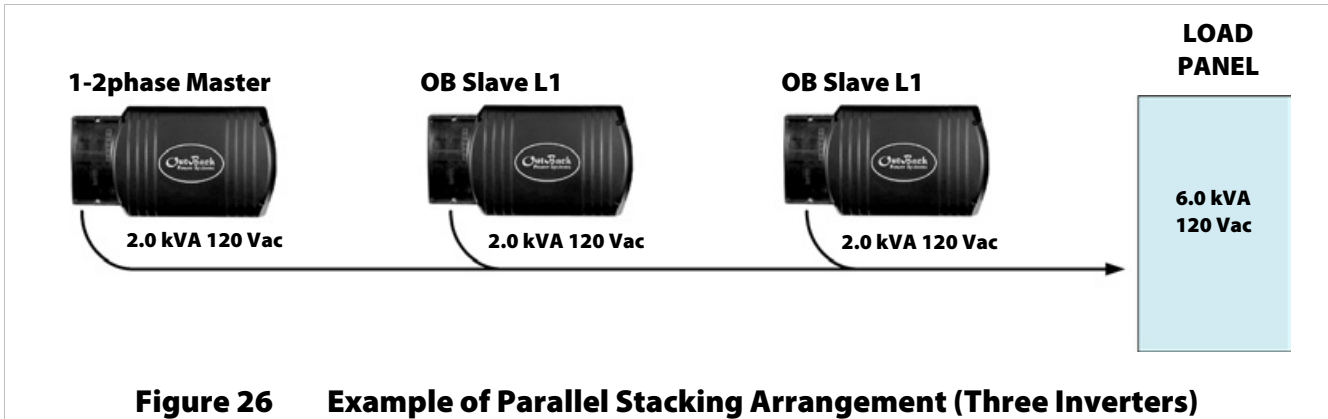



Figure 26 Example of Parallel Stacking Arrangement (Three Inverters)

When installing a parallel inverter system, observe the following rules.

- Parallel stacking requires both a system display and a communications manager. Port assignments and jumper positions vary with model and stacking configuration. 
- The inverter that is mounted physically lowest is always the master. It is the primary output. Mounting the master below the other inverters allows the master to avoid heat buildup and remain relatively cool.
- The master must be connected to communications manager port 1. It is programmed as **1-2phase Master**.  Other inverters must not be selected as master.
- All other inverters, regardless of number, must be programmed as **OB Slave L1** during programming. See the HUB Communications Manager literature for port assignments.
- All overcurrent devices must be sized for 30 Aac or less. All wiring must be sized for 30 Aac or more.
- All output circuit breakers must be sized appropriately for loads and inverter power.
- The AC input (generator or shore power) must be 120 Vac at 60 Hz (single-phase)

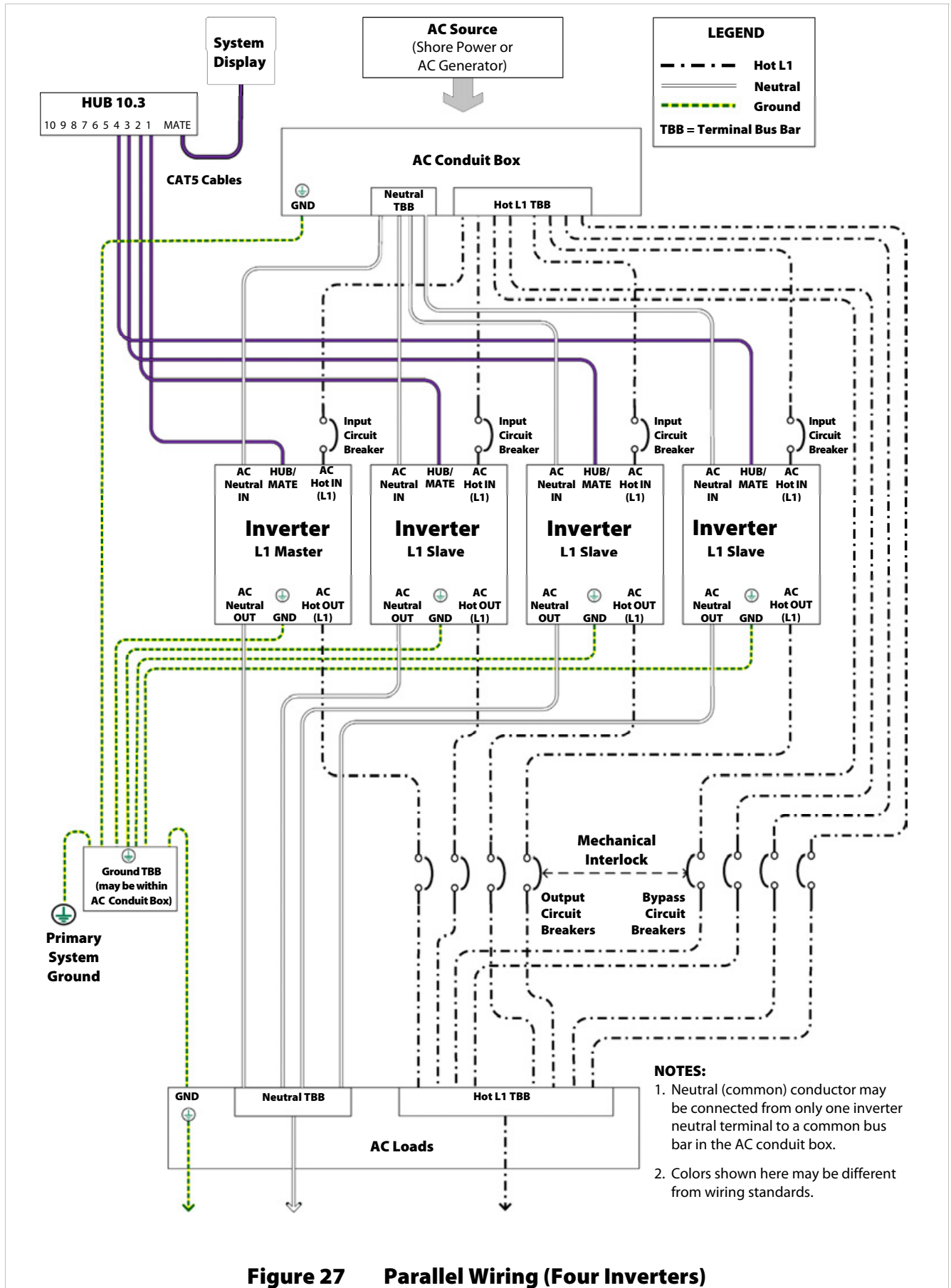
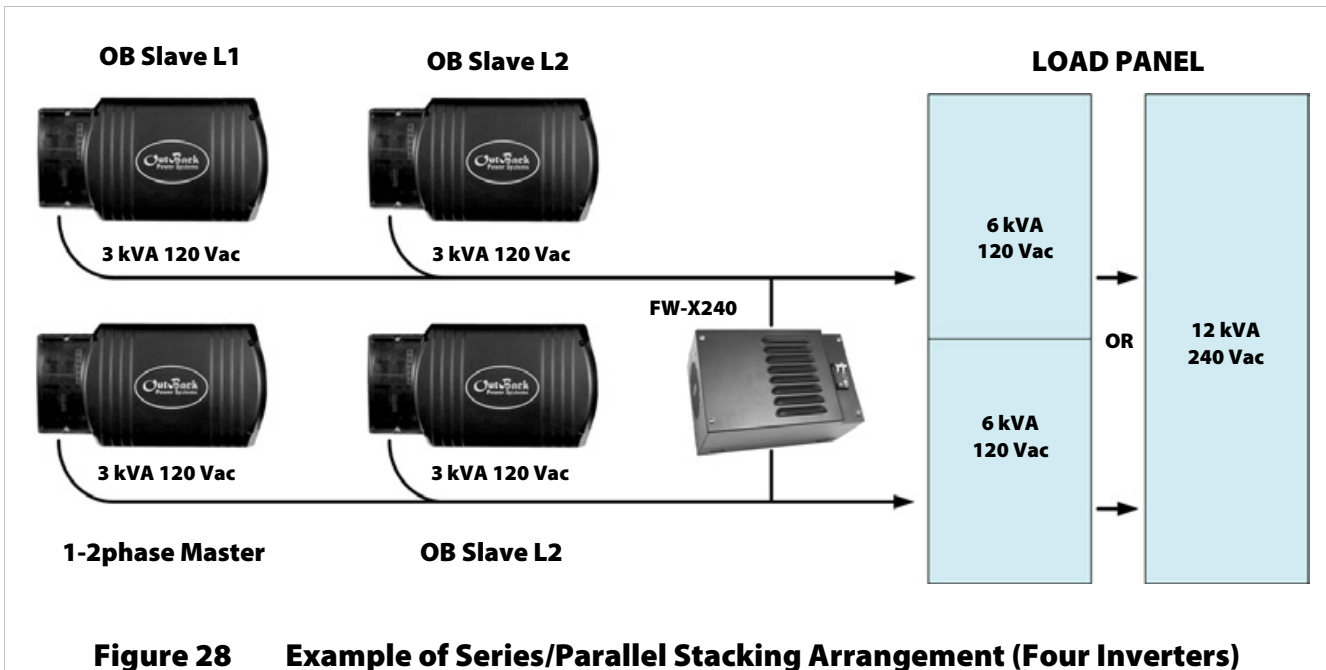

Figure 27 Parallel Wiring (Four Inverters)



Series/Parallel Stacking (Quad-Stack or Larger)

In series/parallel stacking, inverters use OutBack series stacking create separate 120 Vac output phases and 240 Vac collectively. However, in this configuration, each output has parallel inverters. One output contains the master; the other uses a slave. Each output has at least one additional slave.

- The 120 Vac loads on each output can exceed the size of a single inverter. They can be powered by all the inverters on that output.
- The slave outputs cannot operate independently. The slaves can go into Power Save mode when not in use.
- Up to ten inverters may be installed in a series/parallel arrangement. All inverters must be the same model.



When installing a multiple-inverter series/parallel system, observe the following rules.

- Series/parallel stacking requires one or more FW-X240 autotransformers, a system display and a communications manager. Port assignments and jumper positions vary with model and stacking configuration. 
- A system of four mobile FX or VFX inverters can use a single FX-X240 balancing transformer. If more than four inverters are used, the output must be balanced with additional transformers. Two transformers are required for series/parallel systems of up to eight inverters. For a ten-inverter system, three transformers are required.
- The inverter that is mounted physically lowest is always the master. It is the primary L1 output. Mounting the master below the other inverters allows the master to avoid heat buildup and remain relatively cool.
- The master must be connected to communications manager port 1. It is programmed as **1-2phase Master**.  Other inverters must not be selected as master.
- All other inverters on the L1 output, regardless of number, must be programmed as **OB Slave L1** during programming.
- All inverters on the L2 output, regardless of number, must be programmed as **OB Slave L2** during programming. See the HUB Communications Manager literature for port assignments.
- All overcurrent devices must be sized for 30 Aac or less. All wiring must be sized for 60 Aac or more.
- All output circuit breakers must be sized appropriately for loads and inverter power.
- The AC input (generator or shore power) must be 120/240 Vac (split-phase).

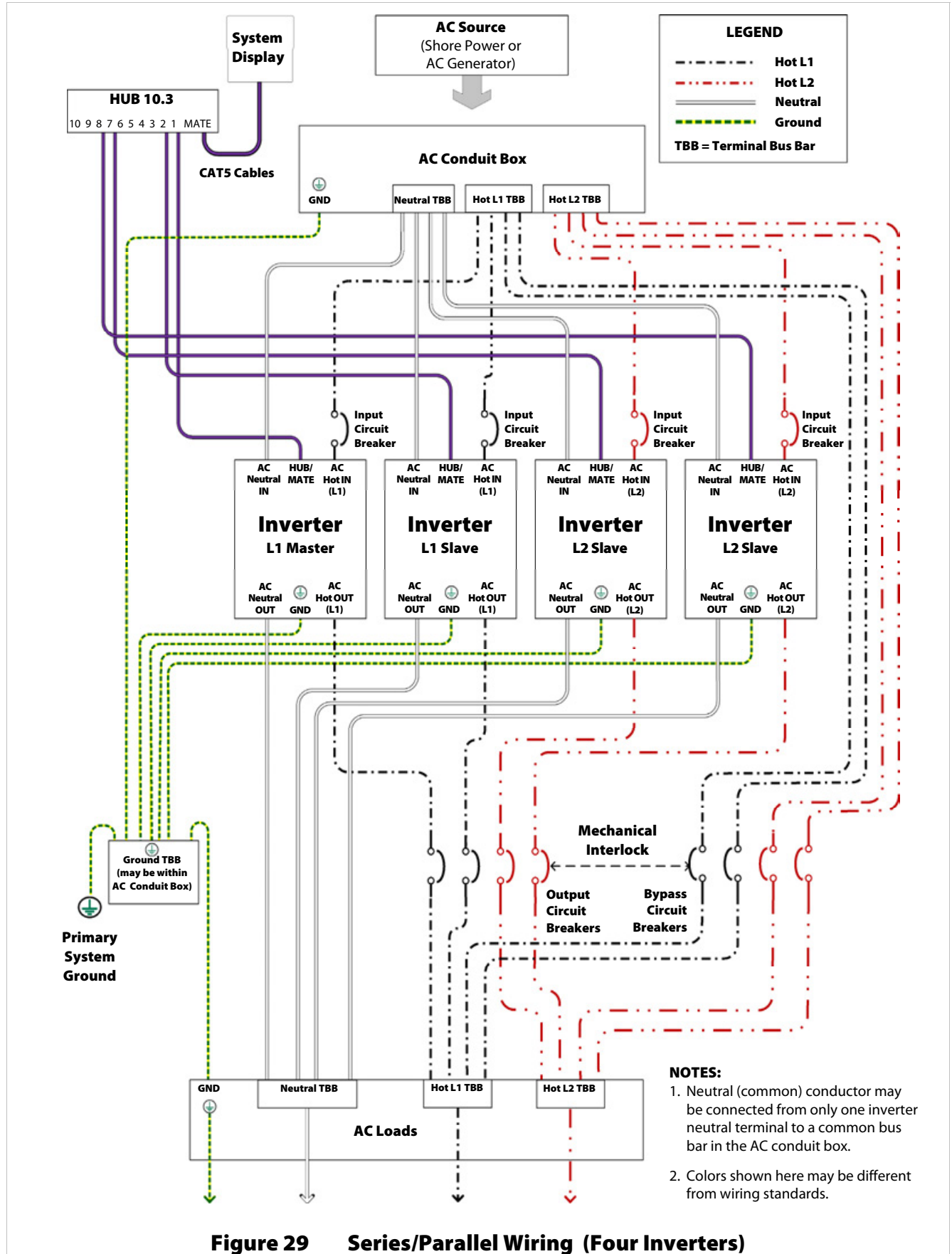
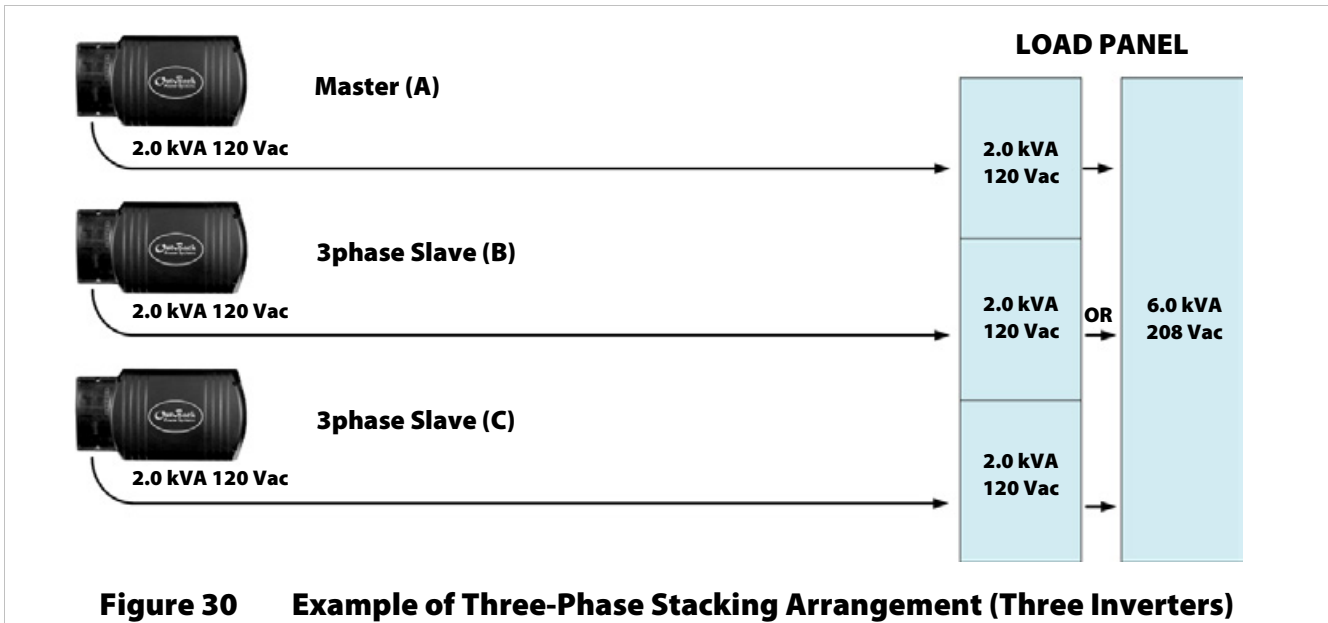

Figure 29 Series/Parallel Wiring (Four Inverters)

Three-Phase Stacking

In three-phase stacking, inverters create three separate 120 Vac output phases in a wye configuration.

- The output of each inverter is 120° out of phase from the others. Any two outputs produce 208 Vac between them. The outputs can be used to power three-phase loads when all inverters work together.
- The 120 Vac loads on each output cannot exceed a given inverter's wattage. The other outputs cannot assist.
- Only three inverters, one per phase, may be installed in a three-phase arrangement. All inverters must be the same model.



When installing a three-phase system, observe the following rules.

- Three-phase stacking requires both a system display and a communications manager. Port assignments and jumper positions vary with model and stacking configuration. 
- The master must be connected to communications manager port 1. It is the Phase A output. It is programmed as **3phase Master**. Other inverters must not be selected as master.
- The Phase B and Phase C inverters must be programmed as **3phase Slave**. See the HUB Communications Manager literature for port assignments.
- All overcurrent devices must be sized for 30 Aac or less. All wiring must be sized for 30 Aac or more.
- All output circuit breakers must be sized appropriately for loads and inverter power.
- The AC input (generator or utility grid) must be a three-phase wye configuration source of the proper voltage and frequency.

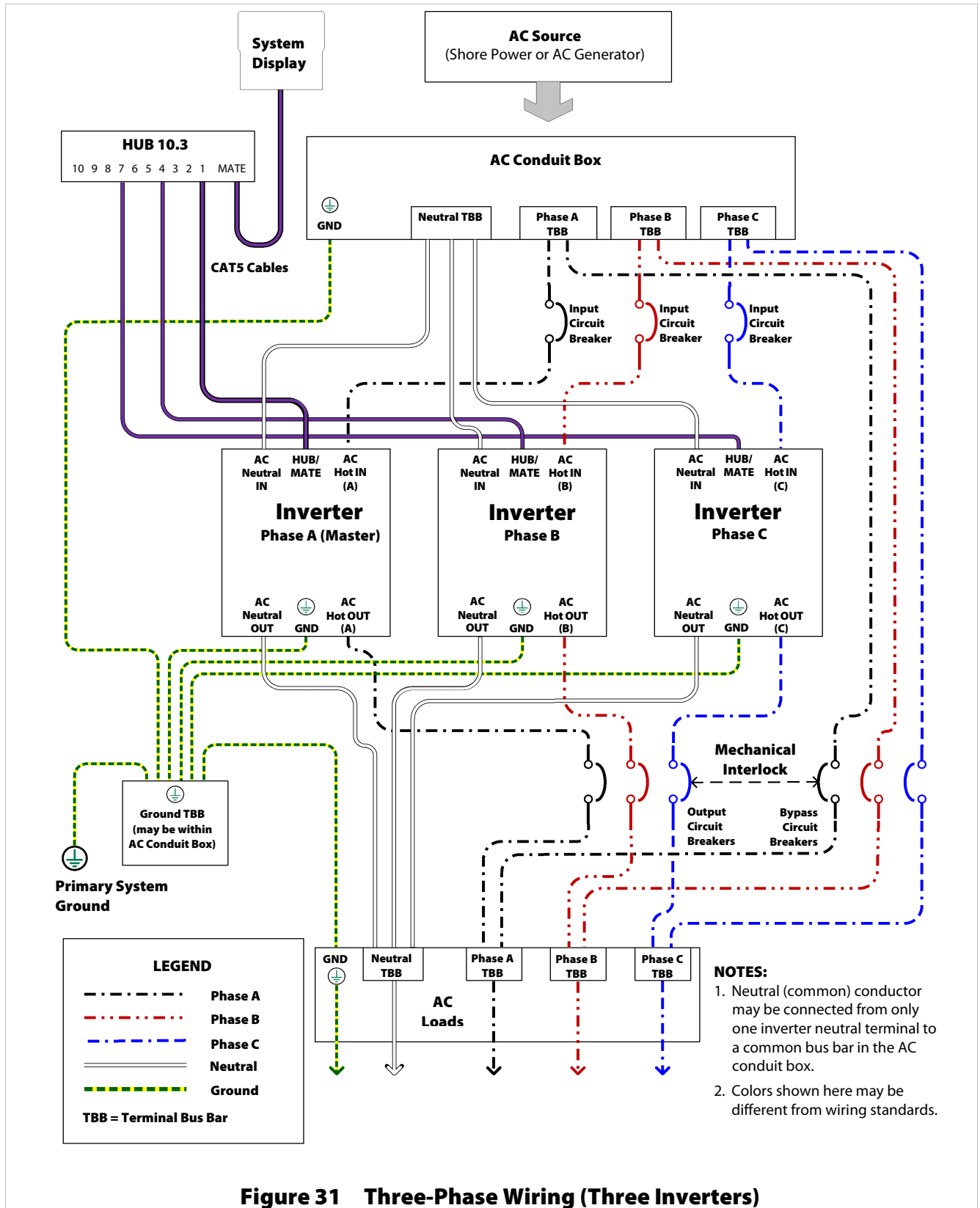

Figure 31 Three-Phase Wiring (Three Inverters)



Commissioning

Functional Test



WARNING: Shock Hazard and Equipment Damage

The inverter's AC and DC covers must be removed to perform these tests. The components are close together and carry hazardous voltages. Use appropriate care to avoid the risk of electric shock or equipment damage.

It is highly recommended that all *applicable* steps be performed in the following order. However, if steps are inapplicable, they can be omitted.

If the results of any step do not match the description, see the Operator's Manual for troubleshooting.

Pre-startup Procedures

1. Ensure all DC and AC overcurrent devices are opened, disconnected, or turned off.
2. Double-check all wiring connections.
3. Confirm that the total load does not exceed the inverter's rated power.
4. Inspect the work area to ensure tools or debris have not been left inside.
5. Using a digital voltmeter (DVM) or standard voltmeter, verify battery voltage. Confirm the voltage is correct for the inverter model. Confirm the polarity.
6. Connect the system display, if present.



CAUTION: Equipment Damage

Incorrect battery polarity will damage the inverter. Excessive battery voltage also may damage the inverter. This damage is not covered by the warranty.



WARNING: Shock Hazard

The inverter's AC output is defaulted to ON from the factory. It will deliver 120 Vac as soon as DC power is connected.

Startup

To start a single-inverter system:

1. Close the main DC circuit breakers (or connect the fuses) from the battery bank to the inverter. The inverter will activate. Do not turn on any AC circuit breakers at this time. Confirm that the system display is operational, if present. 
2. Observe the LED indicators in the AC wiring compartment. One of the three BATTERY indicators should be illuminated (green, yellow, or red). Any of them are acceptable at this stage. INVERTER (green) should come on at this time. The fan will run briefly and the relay will click as a self-test.
3. If a system display is present, perform all programming for all functions. These functions may include input current limits, battery charging, generator starting, and others.

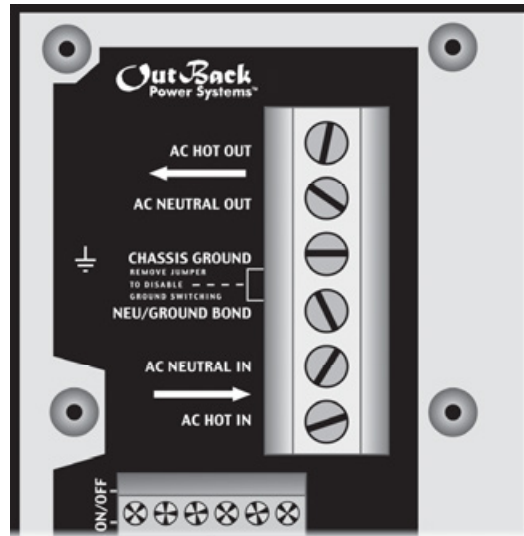

Figure 32 AC Terminals

4. Using a DVM or voltmeter, measure between the AC HOT OUT and AC NEUTRAL OUT terminals. (See Figure 32.) The inverter is working correctly if the AC output reads within 10% of 120 Vac.

Proceed past the items below to Step 5.

To start a multiple-inverter (stacked) system:

1. Close the main DC circuit breakers (or connect the fuses) from the battery bank to the master inverter. The inverter will activate. Do not turn on any AC circuit breakers at this time. Confirm that the system display is operational.
2. Observe the LED indicators in the AC wiring compartment. One of the three BATTERY indicators should be illuminated (green, yellow, or red). Any of them are acceptable at this stage. INVERTER (green) should come on at this time. The fan will run briefly and the relay will click as a self-test.

Repeat steps 1 and 2 for every inverter present.

3. With the system display, perform programming for stacking and all other functions.  These functions may include input current limits, battery charging, and generator starting. All parallel-stacked slave inverters will observe the master programming settings and do not need to be programmed individually. The MATE3 Configuration Wizard may be used to assist programming.
4. Using the system display, temporarily bring each slave out of Silent mode by raising the Power Save Level of the master.
 - As each slave is activated, it will click and create an audible hum.
 - Confirm that the system display shows no fault messages.

Using a DVM or voltmeter, measure between the AC HOT OUT terminal on the master inverter and AC HOT OUT on each slave. Series inverters should read within 10% of 120 Vac. Parallel inverters should read close to zero. Three-phase inverters should read within 10% of 208 Vac.

- When this test is finished, return the master to its previous Power Save Level.

After output testing is completed, perform the following steps:

5. Close the AC output circuit breakers. If AC bypass switches are present, place them in the normal (non-bypass) position. Do not connect an AC input source or close any AC input circuits.
6. Use a DVM to verify correct voltage at the AC load panel.
7. Connect a small AC load and test for proper functionality.

8. Close the AC input circuit breakers and connect an AC source.
 - Using a DVM or voltmeter, check the AC HOT IN and AC NEUTRAL IN terminals for 120 Vac from the AC source.
 - If a system display is present, confirm that the inverter accepts the AC source as appropriate for its programming. (Some modes or functions may restrict connection with the source. If one of these selections has been used for the system, it may not connect.) Check the system display indicators for correct performance.
9. If the charger is activated, the inverter will perform a battery charging cycle after powering up. This can take several hours. If restarted after a temporary shutdown, the inverter may skip most or all of the charging cycle. Confirm that it is charging as appropriate by using the system display.
10. Test other functions which have been enabled, such as generator start or search mode.
11. Compare the DVM's readings with the system display meter readings. If necessary, the system display's readings can be calibrated to match the DVM more accurately. Calibrated settings include AC input voltage, AC output voltage, and battery voltage.

Powering Down

These steps will completely isolate the inverter.

To remove power from the system:

1. Turn off all load circuits and AC input sources.
2. Turn off all renewable energy circuits.
3. Turn each inverter OFF using the system display or external switch.
4. Turn off the main DC overcurrent devices for each inverter.

Adding New Devices

When adding new devices to the system, first turn off the system according to the Power Down instructions. After adding new devices, perform another functional test, including programming.

Operation

Once the mounting, wiring, and other installation steps are completed, proceed to the *FXR Series Inverter/Charger Operator's Manual*.

Refer to the system display manual for programming instructions and menus.

Definitions

The following is a list of initials, terms, and definitions used with this product.

Table 6 Terms and Definitions

Term	Definition
AC	Alternating Current; refers to voltage produced by the inverter, utility grid, or generator
AC Plate	Inverter accessory to accommodate flexible cable when conduit is not used
AGS	Advanced Generator Start
AUX	Inverter's 12-volt auxiliary output
Communications manager	Multi-port device such as the OutBack HUB 4 or HUB10.3; used for connecting multiple OutBack devices on a single remote display; essential for stacking inverters

Table 6 Terms and Definitions

Term	Definition
CSA	Canadian Standards Association; establishes Canadian national standards and the Canadian Electrical Code, including C22.1 and C22.2
DC	Direct Current; refers to voltage produced by the batteries or renewable source
DCC	DC Cover; shields the DC terminal area on vented FXR inverters
DVM	Digital Voltmeter
ETL	Electrical Testing Laboratories; short for the company ETL Semko; refers to a certification issued by ETL to OutBack products indicating that they meet certain UL standards
GFCI	Ground Fault Circuit Interruptor; a safety device for electrical systems
GND	Ground; a permanent conductive connection to earth for safety reasons; also known as Chassis Ground, Protective Earth, and PE
HUB	An OutBack communications manager product; used for system stacking and coordination
Invert, inverting	The act of converting DC voltage to AC voltage for load use or other applications
LED	Light-Emitting Diode; refers to indicators used by the inverter and the system display
Master	An inverter which provides the primary output phase of a stacked system; other stacked inverters base their output and on/off state on the master
MATE, MATE2, MATE3	System display products, used for monitoring, programming and communicating with the inverter
NEU	AC Neutral; also known as Common
Neutral-to-ground bond	A mechanical connection between the AC neutral (Common) bus and the ground (PE) bus; this bond makes the AC neutral safe to handle
PV	Photovoltaic
RTS	Remote Temperature Sensor; accessory that measures battery temperature for charging
Slave	An inverter which adds additional power to the master in a stacked system; a slave does not provide an output of its own
Split-phase	A type of utility electrical system with two “hot” lines that typically carry 120 Vac with respect to neutral and 240 Vac with respect to each other; common in North America
System display	Remote interface device, used for monitoring, programming and communicating with the inverter; also called “remote system display”
Three-phase, 3-phase	A type of utility electrical system with three “hot” lines, each 120° out of phase; each carries the nominal line voltage with respect to neutral; each carries voltage with respect to each other equaling the line voltage multiplied by 1.732
Turbo Fan	External cooling fan used in place of the DCC on sealed FX inverters
UL	Underwriters Laboratories; refers to a set of safety standards governing electrical products
Utility grid	The electrical service and infrastructure supported by the electrical or utility company; also called “shore power”, “mains”, “utility service”, or “grid”



Index

A

AC Plate.....	8
AC Sources.....	22
AC Terminals.....	9, 15, 21
AC Test Points.....	42
Adding New Devices.....	43
Advanced Generator Start (AGS).....	25
Alternator.....	9, 10
Applications.....	9
Automatic Generator Start.....	25
AUX Terminals.....	15
AXS Port.....	6

B

Battery Bank.....	10
Sizing.....	11
Battery Terminal Covers.....	8, 19

C

Caution Symbol.....	5
Classic Series Stacking.....	30
Commissioning.....	41
Communication Cables.....	15, 23, 28
Communications Connections.....	29
Communications Manager	
Connections.....	15, 23, 28
Stacking.....	30, 32, 34, 36, 38
Components.....	8
Conductor Size	
AC Conductors.....	21
DC Conductors.....	18
Ground Conductors.....	16
Control Wiring Terminal Block.....	15

D

DC Cover (DCC).....	8, 13, 20
DC Terminals.....	15, 18, 19
Definitions.....	43
Dimensions.....	14
Diversion Control.....	24
Drawings	
General System Layout.....	9

Parallel-Stacked System.....	35
Single-Inverter System.....	27
Three-Phase System.....	39
DVM.....	13, 41, 42

E

Environmental Requirements.....	13
---------------------------------	----

F

Features.....	6
Functional Test.....	41

G

Gen Alert.....	25
Generator.....	27, 34, 36, 38
Applications.....	9, 22
Control.....	25, 26
Sizing.....	12
Type.....	12, 30, 32
GFDI.....	16
Grounding.....	15, 16

H

HUB10.3.....	23, 28
--------------	--------

I

Important Symbol.....	5
Ingress Protection (IP).....	13

J

Jumper.....	15, 23
-------------	--------

L

LED Indicators.....	15
Listings.....	6
Location.....	13

Index

M

Master (Stacking).....	28, 34, 36, 38
MATE, MATE2, MATE3.....	6, 9, 23, 28
MATE/HUB Port.....	23
MATE3.....	44
Models.....	7
Mounting.....	14
Multiple AC Sources.....	22

N

Neutral-Ground Bonding.....	12, 16, 17, 21, 22
Note Symbol.....	5

O

On and Off.....	15, 23
OPTICS RE.....	6
OutBack Series Stacking.....	32

P

Parallel Stacking.....	34
Ports, RJ45 and RJ11.....	15, 23
Positive Grounding.....	16
Powering Down.....	43
PV9, 10.....	

R

Relative Humidity (RH).....	13
Relay.....	25
Remote Temperature Sensor (RTS).....	8, 15, 23

S

Safety.....	5
Sealed Models.....	13
Series/Parallel Stacking.....	36
Shore Power.....	27, 34, 36, 38
Applications.....	9, 22
Type.....	30, 32
Sizing.....	27
Slave (Stacking).....	28, 34, 36, 38
Stacking.....	28
Classic Series.....	30
Commissioning.....	42

OutBack Series.....	32
Parallel.....	34
Series/Parallel.....	36
Three-Phase.....	38
Stacking Mode Programming.....	29
Startup.....	41
Symbols Used.....	5
System Display.....	43, 44
Connections.....	15, 23
Programming.....	12, 24, 25, 28
Stacking.....	30, 32, 34, 36, 38

T

Temperatures.....	13
Terms and Definitions.....	43
Test.....	41
Test Points.....	42
Three-Phase Stacking.....	38
Tools Required.....	13
Torque Requirements.....	
AC Terminals.....	21
DC Terminals.....	18
Ground Terminals.....	16
Transformer.....	12
Turbo Fan.....	8, 20

V

Vent Fan.....	24
Vented Models.....	13

W

Warning Symbol.....	5
Wiring.....	16
AC Connections.....	21
AUX Connections.....	24
DC Connections.....	18
Ground Connections.....	16
Single Inverter.....	27
Stacking.....	
Parallel.....	35
Three-phase.....	39

X

XCT.....	15
----------	----

This page intentionally left blank.

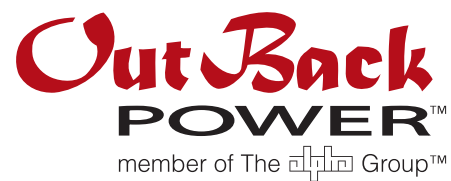

Masters of the Off-Grid.™ First Choice for the New Grid.

Corporate Headquarters
17825 – 59th Avenue N.E.
Suite B
Arlington, WA 98223 USA
+1.360.435.6030

European Office
Hansastraße 8
D-91126
Schwabach, Germany
+49.9122.79889.0